

# INSTALLATION MANUAL

CALIBRE

This installation guide outlines the recommended installation method for Gerard's Calibre product range. While this guide covers the majority of commonly referred-to roof details, it does not cover all areas of each individual roof. If uncertain of any roof detail, please contact us.

Please note that local building codes may have additional requirements not outlined in this document and will supersede these installation recommendations.

To get the best performance from your roof we recommend referring to our Roof Maintenance Guide and Gerard Warranty documents.

### **Important note for Australian installations**

This installation guide is based on installation in accordance with the New Zealand Building Code. For installation within Australia, this manual must be used in conjunction with the Installation Addendum which further outlines Australian-specific requirements. Please note that local building codes may have additional requirements not outlined by Gerard and will supersede the installation recommendations outlined in this manual and the Installation Addendum.



#### **New Zealand**

W: [www.gerardroofs.co.nz](http://www.gerardroofs.co.nz)

E: [customerservice@gerardroofs.co.nz](mailto:customerservice@gerardroofs.co.nz)

P: 0800 100 244

#### **Australia**

W: [www.gerardroofs.com.au](http://www.gerardroofs.com.au)

E: [info@gerardroofs.com.au](mailto:info@gerardroofs.com.au)

P: 1800 249 616

# TABLE OF CONTENTS

DETAIL	PAGE	DETAIL	PAGE
Product Information	04	Area Specific Details	30
Product Specification	05	Ridges	31
Accessory Overview	06	Hips	34
Fastener Details	08	Trims	36
Recommended Tools	10	Valleys	37
Builder's Scope	11	Spill Out Valleys	40
Plywood Installation	12	Barges	42
Plywood Framing Detail	13	Split Gable Barges	44
Plywood Installation	14	Wall Junctions	45
Barge Board Detail	15	Side Walls	46
Eaves Detail	16	Head Walls	48
Head Wall Detail	17	Head Walls – Ventilated	50
Ridge Gap Detail	18	Hip to Wall Junction	52
Valley Board Detail	19	Roof Penetrations	56
Chimney Framework Detail	20	Chimney Penetrations	57
Skylight Framework Detail	21	Dektite Penetrations	59
Eaves Installation	22	Raised Skylight Penetrations	60
Eaves	23	Inset Skylight Penetrations	62
Panel Installation	25	Other Details	64
Panel Installation	26	Change of Pitch	65
Common Cut Guide	27	Change of Pitch - Shortcourse	66
Short Course Installation	29		

# 01. PRODUCT INFORMATION

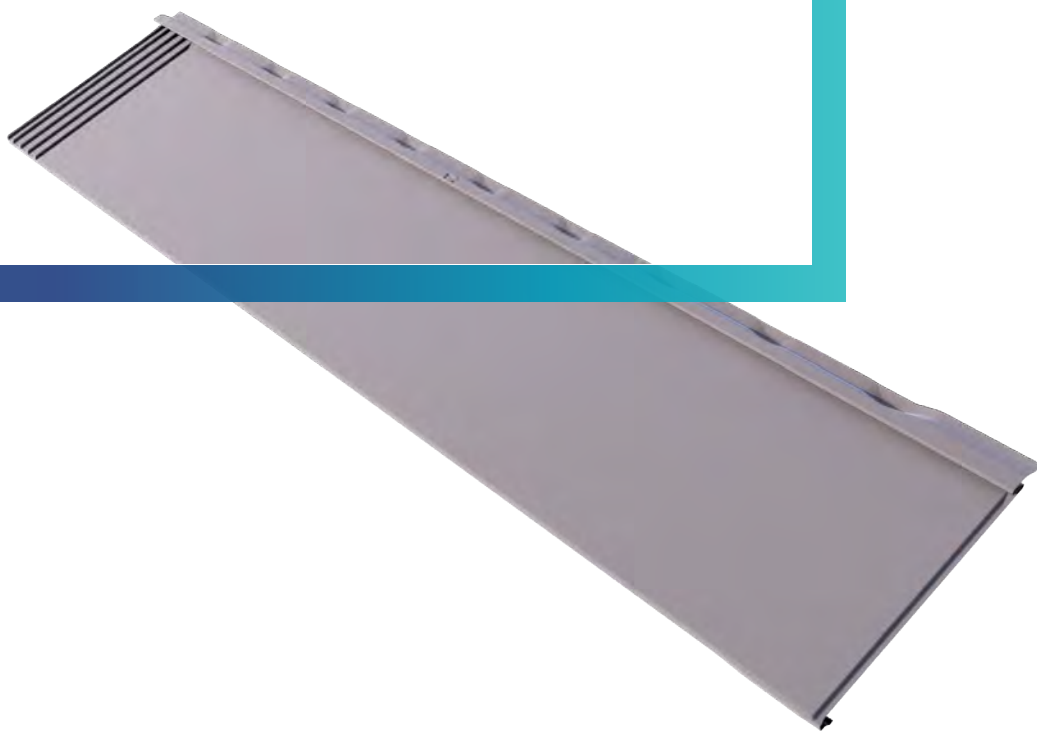

INSTALLATION MANUAL  
CALIBRE

# PRODUCT SPECIFICATION

## CALIBRE

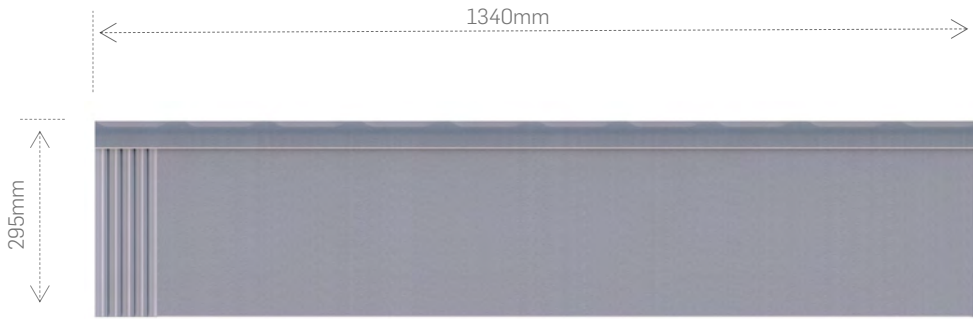

Overall Length	Cover Length	Width	Cover Width	Panels/sqm	Weight	Minimum Roof pitch
1340mm	1250mm	295mm	250mm	3.12 pcs/sqm	6.5kg/sqm	10°

## FASTENING REQUIREMENTS

Tile fastenings in Wind Zone up to and including Extra High	5 screws/panel	10G x 40mm long, hex head needle point screws, hot dipped galvanised steel
---	----------------	--

# ACCESSORY OVERVIEW

## 550 CALIBRE LONG ANGLE TRIM

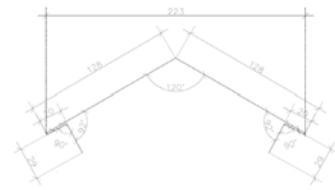
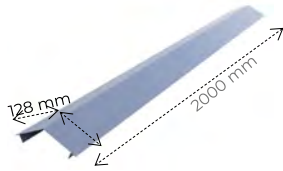

## 551 CALIBRE BARGE COVER

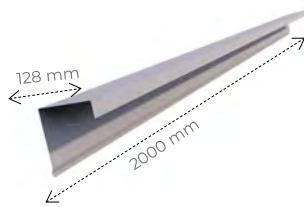

## 553 CALIBRE VALLEY

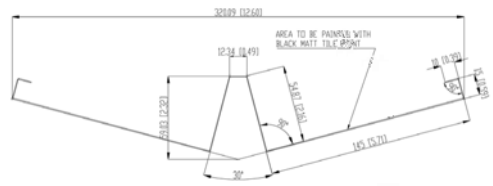
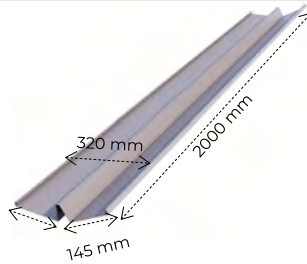
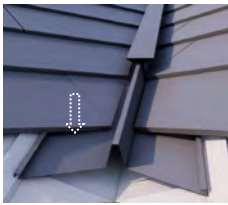

## 554 CALIBRE VALLEY COVER

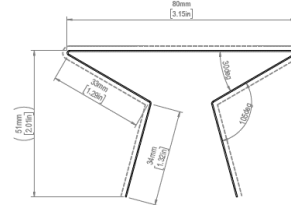
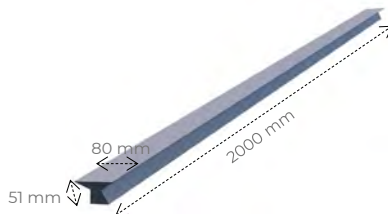

## 556 CALIBRE BARGE CHANNEL

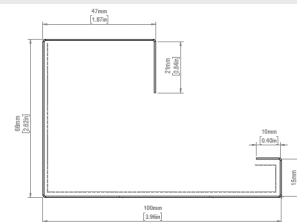
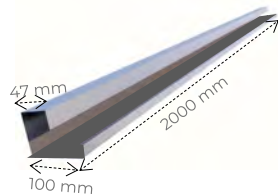
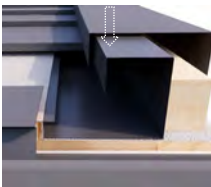

## 564 CALIBRE SPLIT GABLE FLASHING

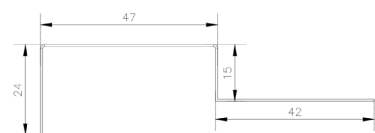
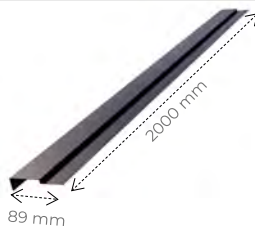
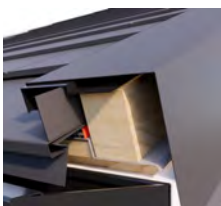

# ACCESSORY OVERVIEW

## 558 CALIBRE HEAD WALL FLASHING

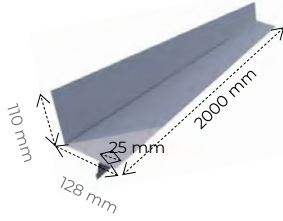

## 560 CALIBRE SIDE WALL FLASHING

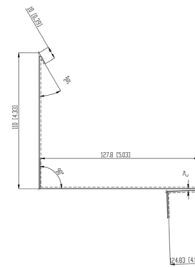
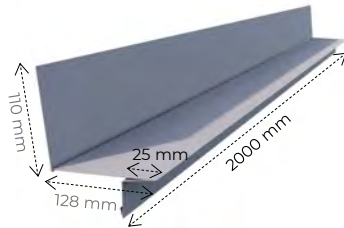
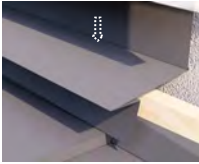

## 561 CALIBRE EAVES FLASHING

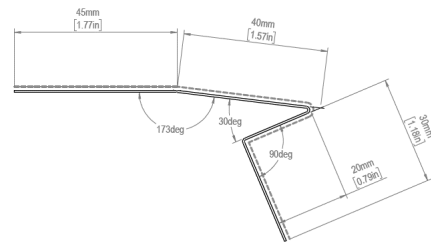
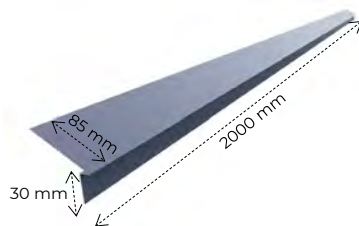

## 104 SIDE FLASHING

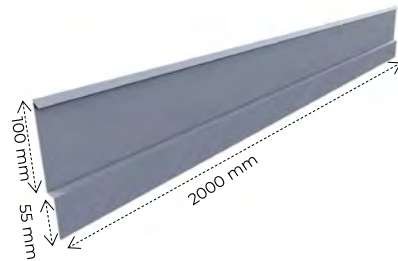

## 417 SHORTCOURSE

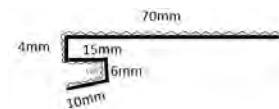
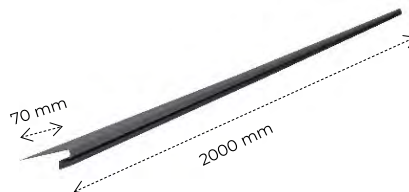
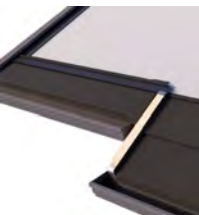

# FASTENER DETAILS

## 550 CALIBRE LONG ANGLE TRIM



10G x 40mm long  
hex head needle  
point screws, hot  
dipped galvanised

5x @ 300mm  
centres

## 551 CALIBRE BARGE COVER

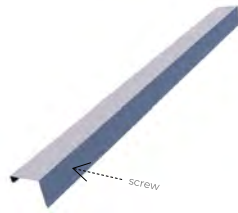

10G x 40mm long  
hex head needle  
point screws, hot  
dipped galvanised

5x @ 300mm  
centres

## 553 CALIBRE VALLEY



Valley is held in  
place with clip or  
nail bent over the  
top of the valley

## 554 CALIBRE VALLEY COVER

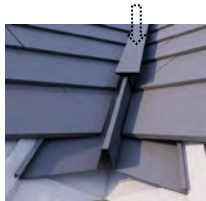

10G x 40mm long  
hex head needle  
point screws, hot  
dipped galvanised

5x @ 300mm  
centres

## 556 CALIBRE BARGE CHANNEL

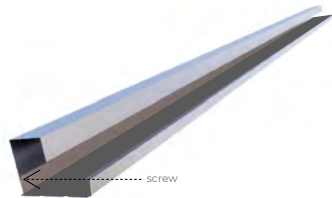
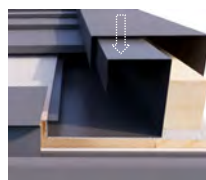

10G x 40mm long  
hex head needle  
point screws, hot  
dipped galvanised

5x @ 300mm  
centres

## 564 CALIBRE SPLIT GABLE FLASHING

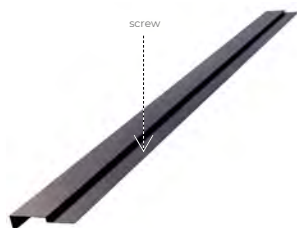

10G x 40mm long  
hex head needle  
point screws, hot  
dipped galvanised

5x @ 300mm  
centres



# FASTENER DETAILS

## 558 CALIBRE HEAD WALL FLASHING

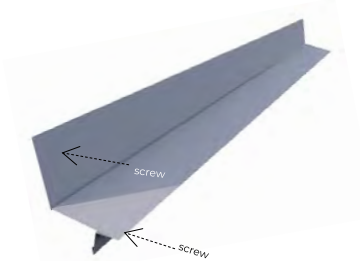

10G x 40mm long  
hex head needle  
point screws, hot  
dipped galvanised

4x @ 500mm  
centres

## 560 CALIBRE SIDE WALL FLASHING

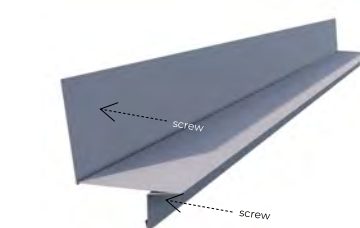
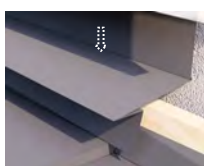

10G x 40mm long  
hex head needle  
point screws, hot  
dipped galvanised

4x @ 500mm  
centres

## 561 CALIBRE EAVES FLASHING

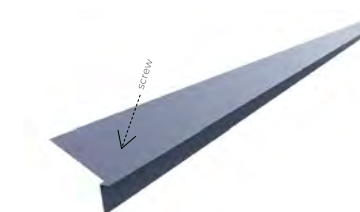

10G x 40mm long  
hex head needle  
point screws, hot  
dipped galvanised

9x @ 200mm  
centres

## 104 SIDE FLASHING



10G x 40mm long  
hex head needle  
point screws, hot  
dipped galvanised

4x @ 500mm  
centres

## 417 SHORTCOURSE

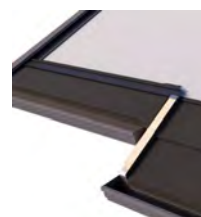

10G x 40mm long  
hex head needle  
point screws, hot  
dipped galvanised

9x @ 200mm  
centres

## RECOMMENDED TOOLS



Tape Measure



Silicone Gun



Nail Gun



Hammer



Impact Driver or Drill



Soapstone



Snips



Bender



Handbender



Guillotine



Riveter



Bevel

# 02. BUILDER'S SCOPE

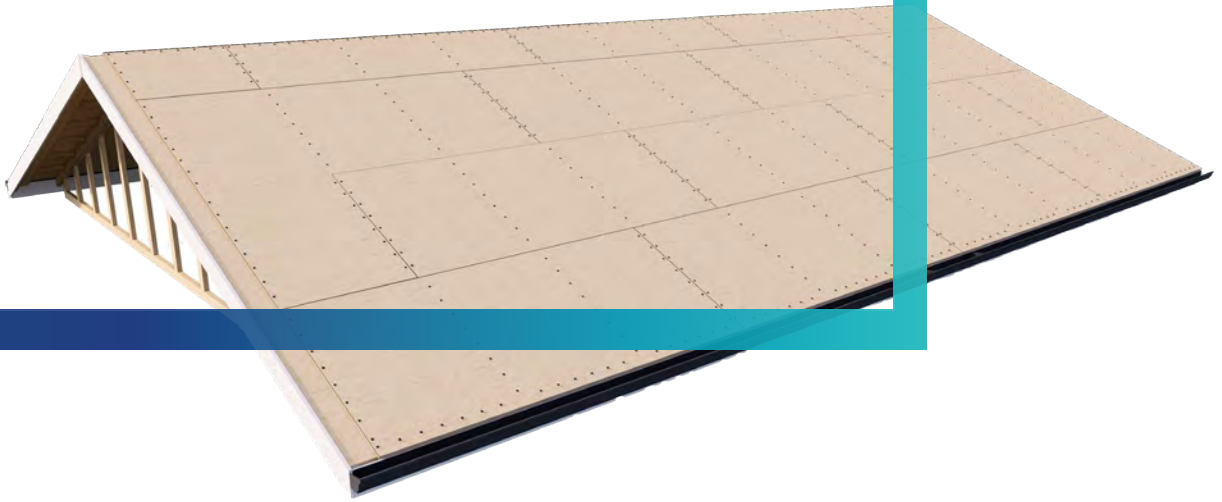

INSTALLATION MANUAL  
CALIBRE

# PLYWOOD INSTALLATION

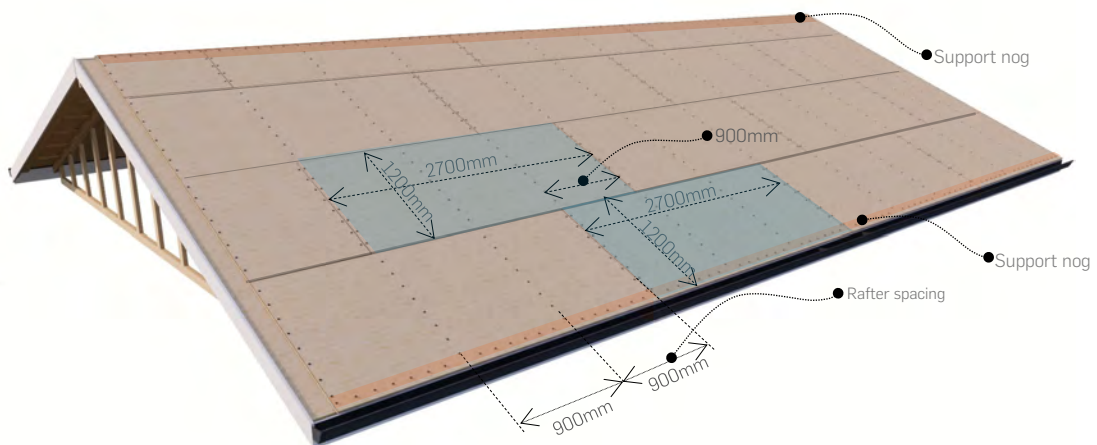

These guidelines and requirements are related to the installation of structural grade plywood for roofing purposes.

Thickness and Fastening	The structural grade plywood used for roofing must be at least 15mm thick. It should be fastened to the rafters using 65mm ring shank nails placed at 150mm intervals along the plywood.
Flush Installation	The plywood must be installed in such a way that it sits flush with the fascia board, ensuring a seamless and even surface.
Treatment of LOSP-Treated Plywood	If LOSP-treated plywood is used, it must be allowed to sit for at least one week before the roofing tile underlay is installed. This allows the solvents in the treatment to evaporate off, ensuring better adhesion of the underlay.
Truss Spacing:	The trusses (rafters) must be spaced at a maximum of 900mm centres for the plywood to be installed. Depending on the spans and wind zones, closer rafter spacings may be required. These spacing requirements should be determined by NZS 3604, specifically table 10.1.
Butt Joint Installation	When joining plywood sheets end to end, a 2-3mm cap should be applied over the timber framing to ensure a secure and stable connection.
Plywood Face Grain and Joint Pattern	The face grain of the plywood sheets must be laid at the right angle to provide adequate support. The sheets must be applied in a staggered brick bond pattern, which helps distribute the loads more evenly.
Tongue and Groove Edges	When using tongue and groove plywood, the edges should be butt-jointed, leaving no gaps between the sheet edges. On the other hand, square plywood edges should have a 2-3mm gap between the sheet edges, allowing for expansion and contraction due to environmental changes.

These guidelines are essential to ensure a proper and safe installation of structural grade plywood for roofing. Always follow the manufacturer's recommendations and local building codes when carrying out any construction work.

# PLYWOOD FRAMING DETAIL

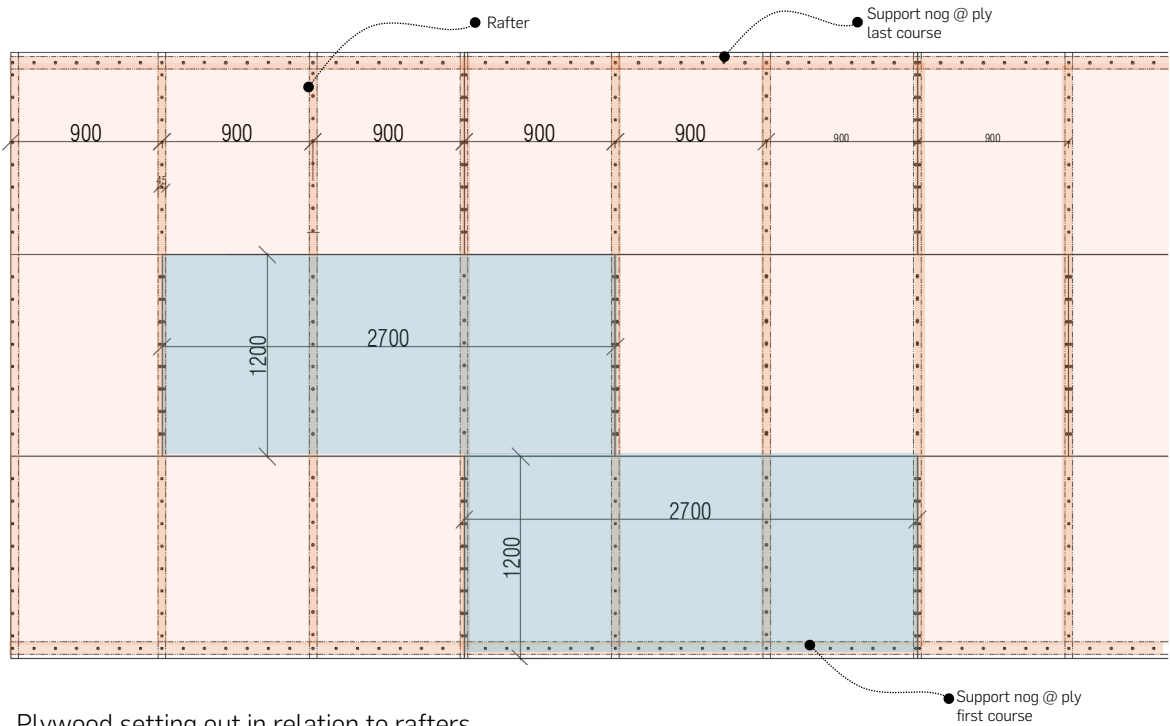

Plywood setting out in relation to rafters

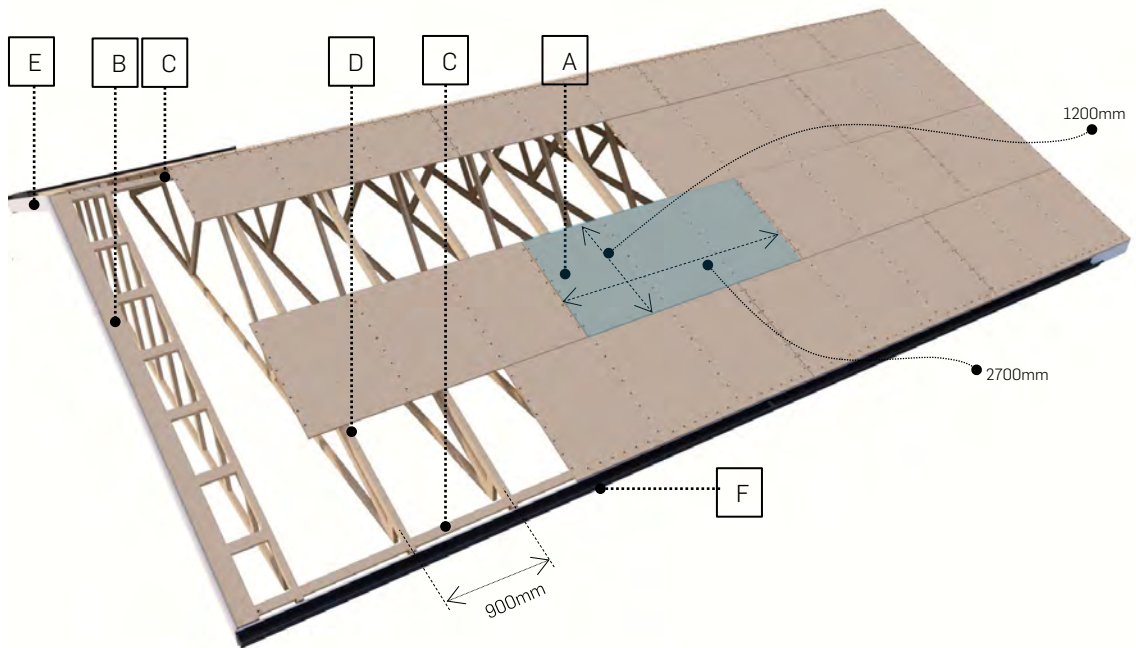

## COMPONENTS

- |   |                 |
|---|-----------------|
| A. Structural grade 15mm thick plywood                | D. Rafter       |
| B. Support nog barge board                            | E. Fascia board |
| C. Support nog for plywood nosing and head/top course | F. Gutter       |

## PLYWOOD INSTALLATION

Erect the roof framing complete with fascia board and gutter.

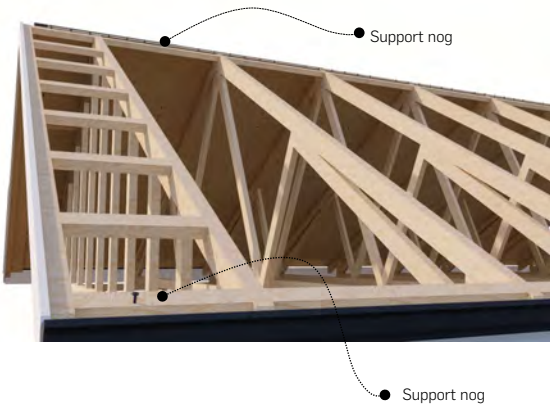

Install barge channel board and support nog.

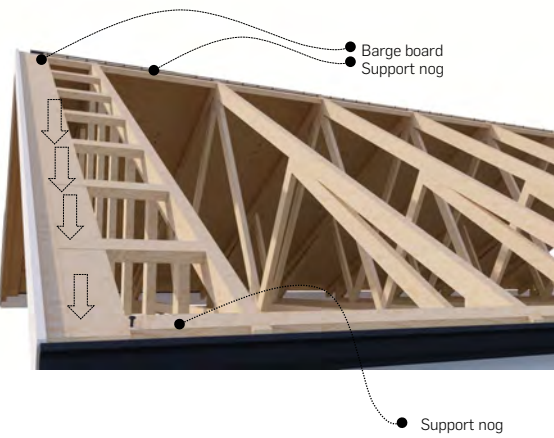

Install 15mm thick structural grade plywood.

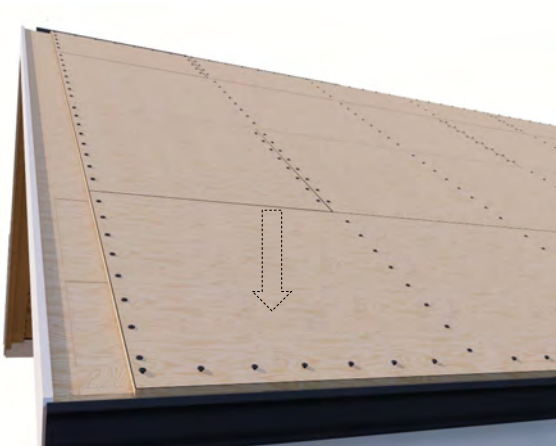

# BARGE BOARD DETAIL

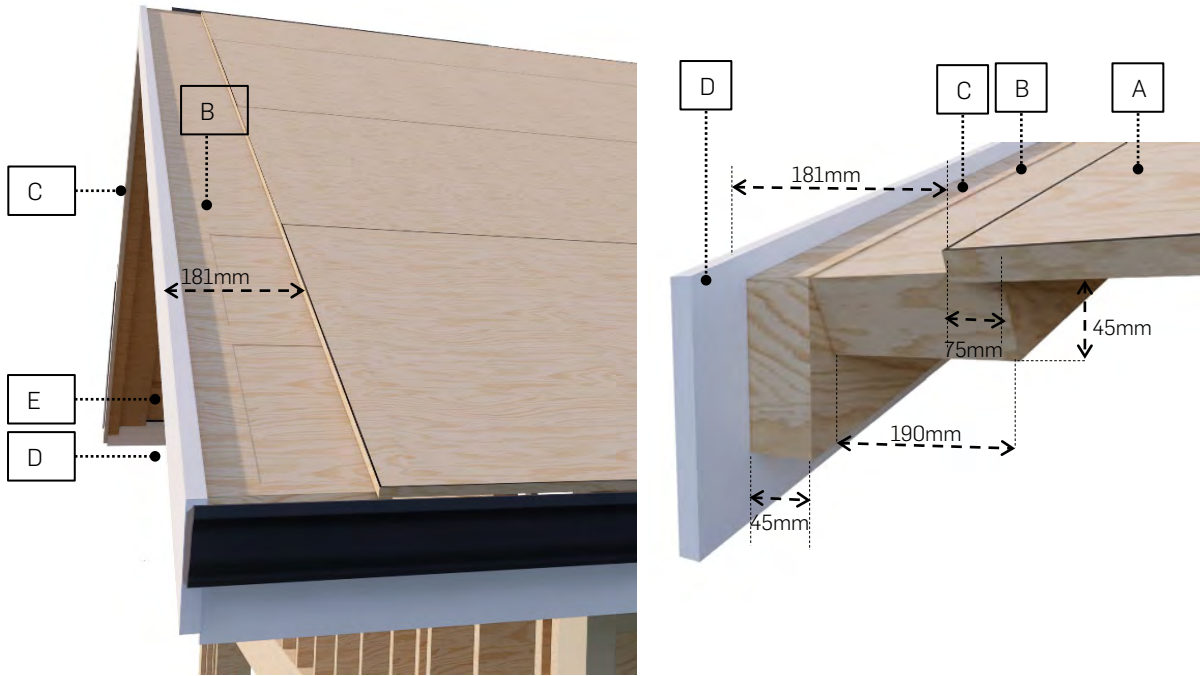

## COMPONENTS

- A. Structural grade 15mm thick plywood
- B. Barge channel board
- C. Flying rafter
- D. Fascia board
- E. Gutter

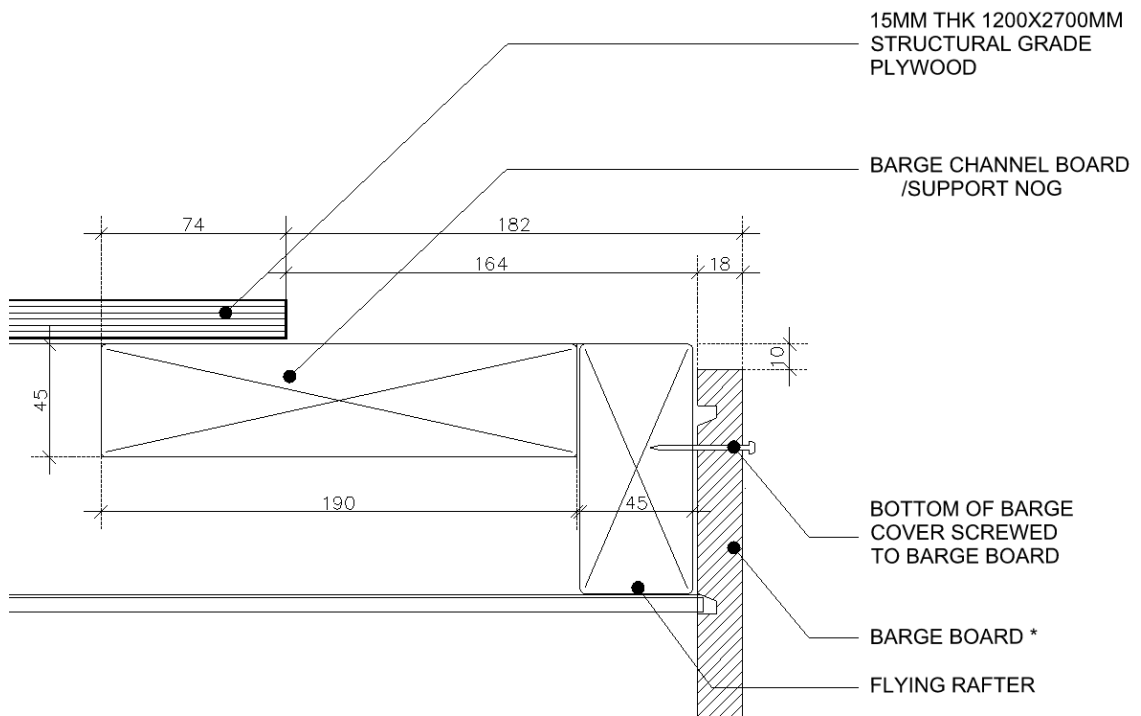

# EAVES DETAIL

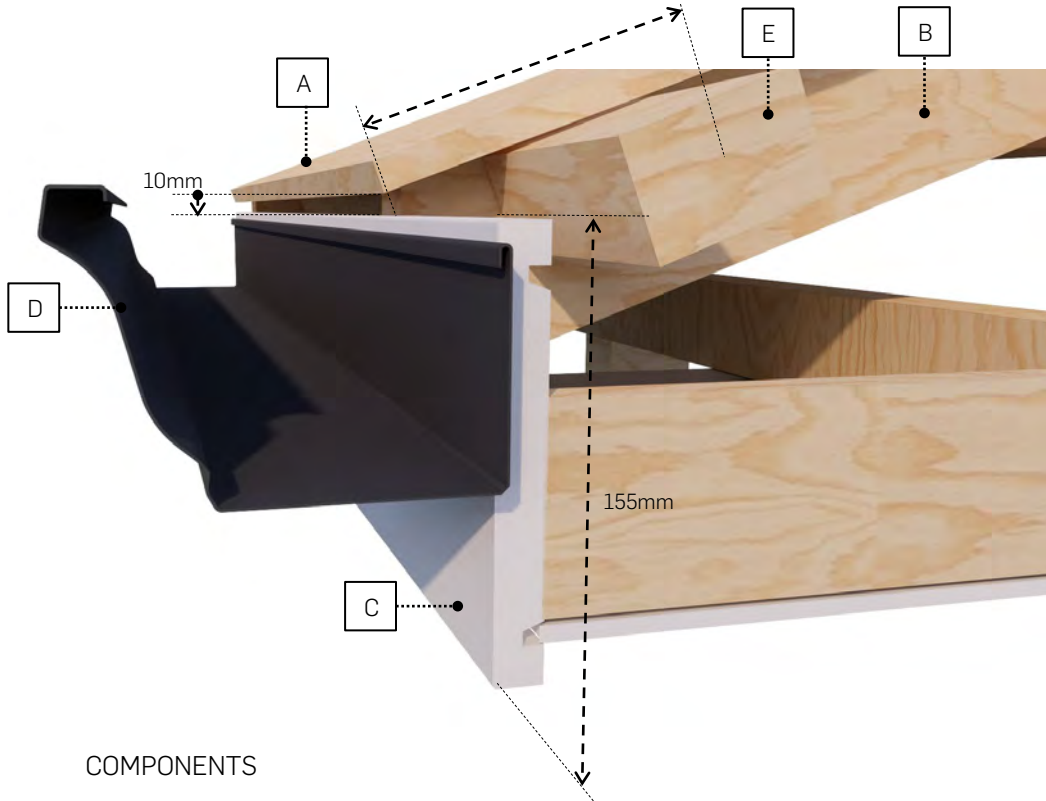

## COMPONENTS

- A. Structural grade 15mm thick plywood
- B. Rafter
- C. Fascia board
- D. Gutter
- E. Support nog

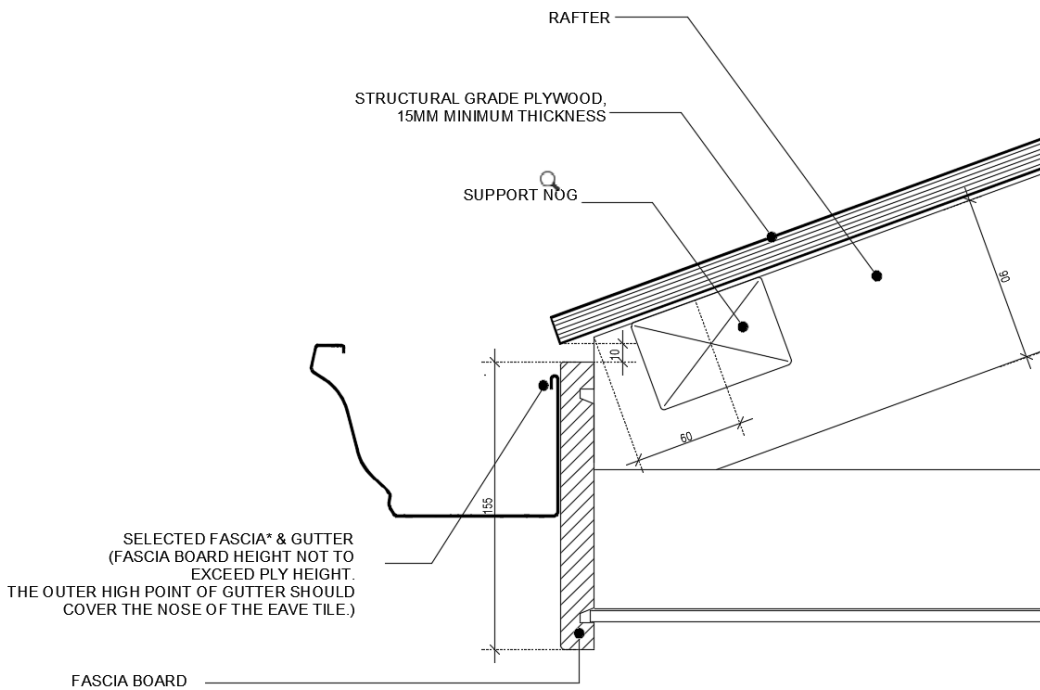



# HEAD WALL DETAIL

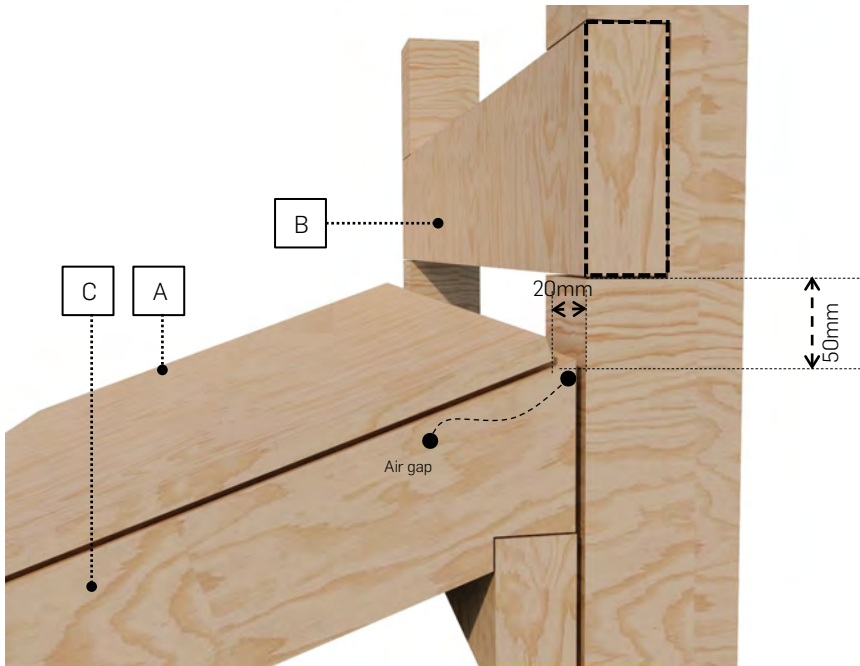

## COMPONENTS

- A. Structural grade 15mm thick plywood
- B. Support nog
- C. Rafter

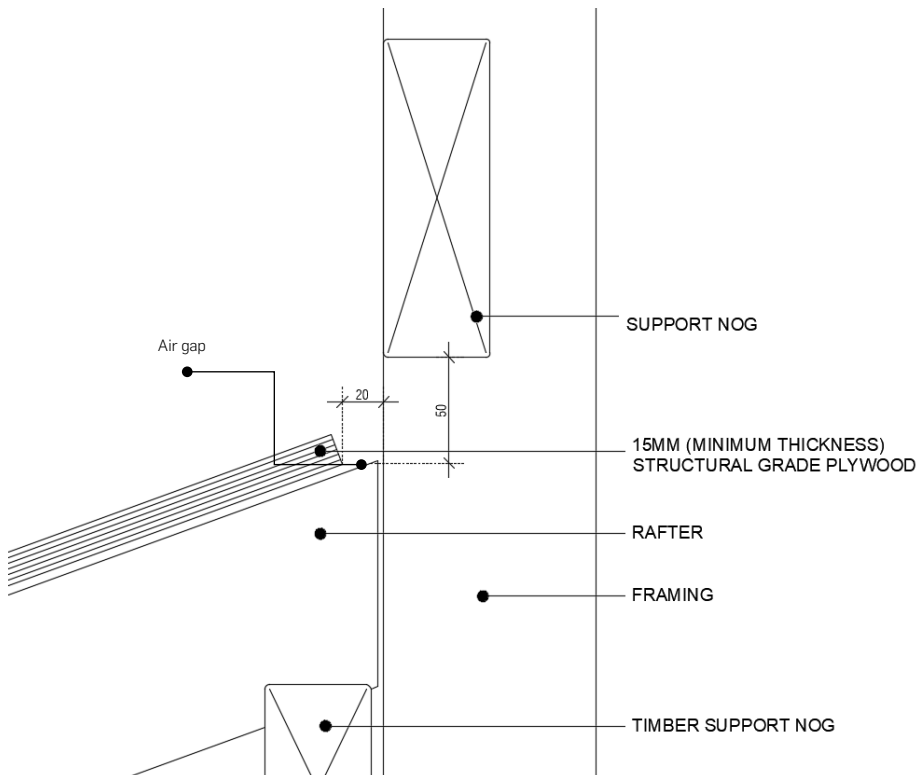

# RIDGE GAP DETAIL

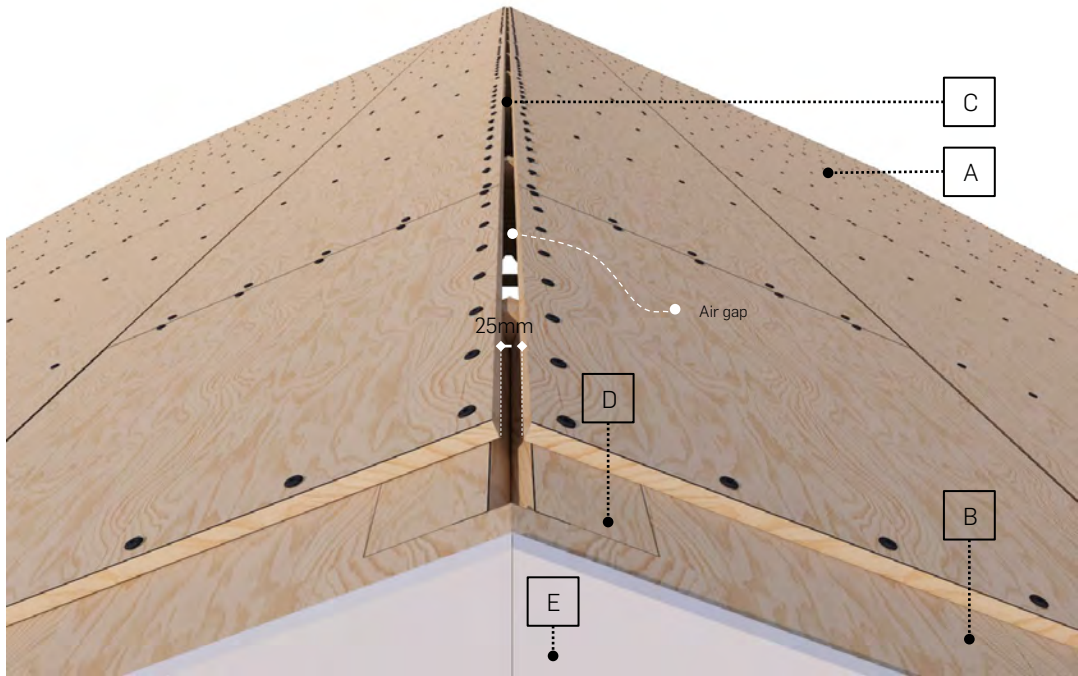

## COMPONENTS

- |  |                      |
|--|----------------------|
| A. Structural grade 15mm thick plywood | D. Ridge support nog |
| B. Barge channel board/nog             | E. Fascia board      |
| C. Rafter                              |                      |

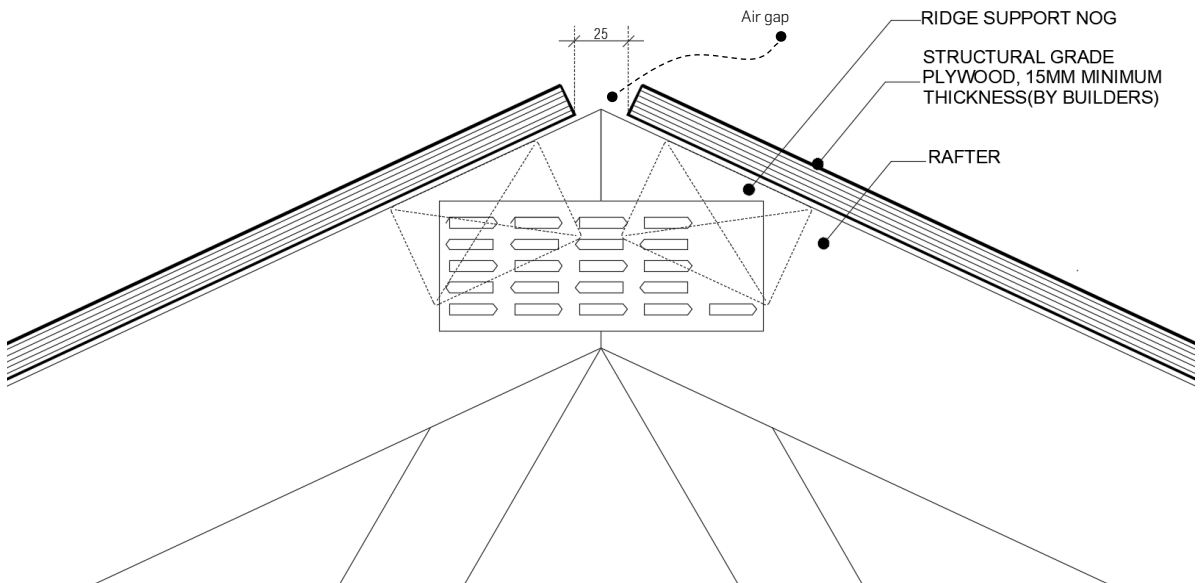

# VALLEY BOARD DETAIL

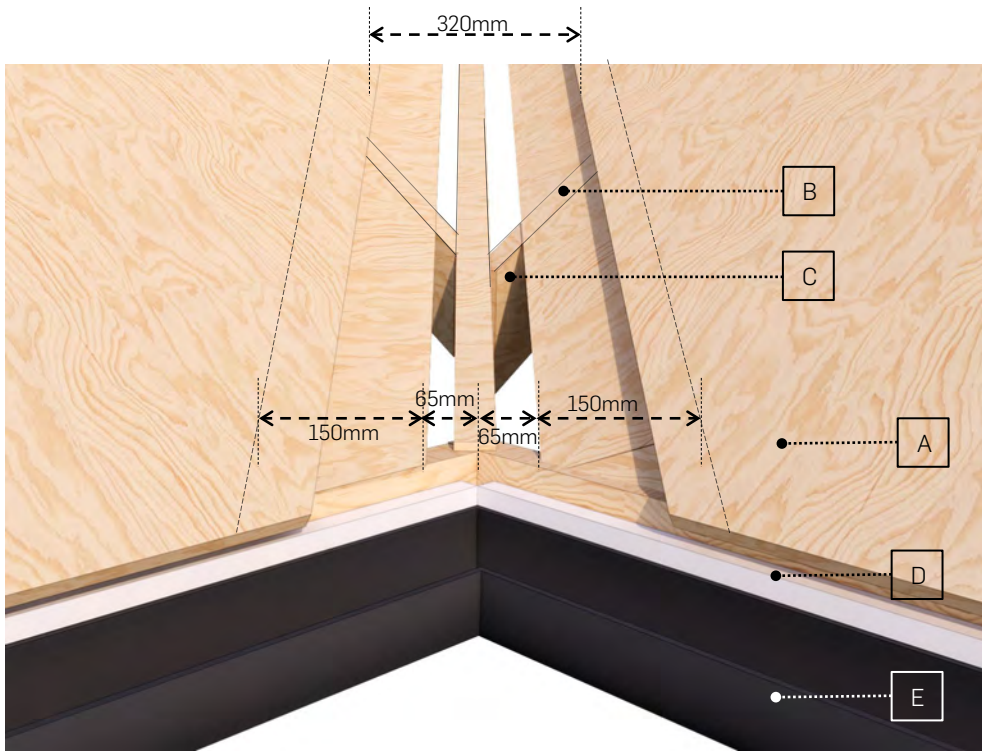

## COMPONENTS

- |  |                 |
|--|-----------------|
| A. Structural grade 15mm thick plywood | D. Fascia board |
| B. 150x25mm valley board               | E. Gutter       |
| C. Rafter                              |                 |

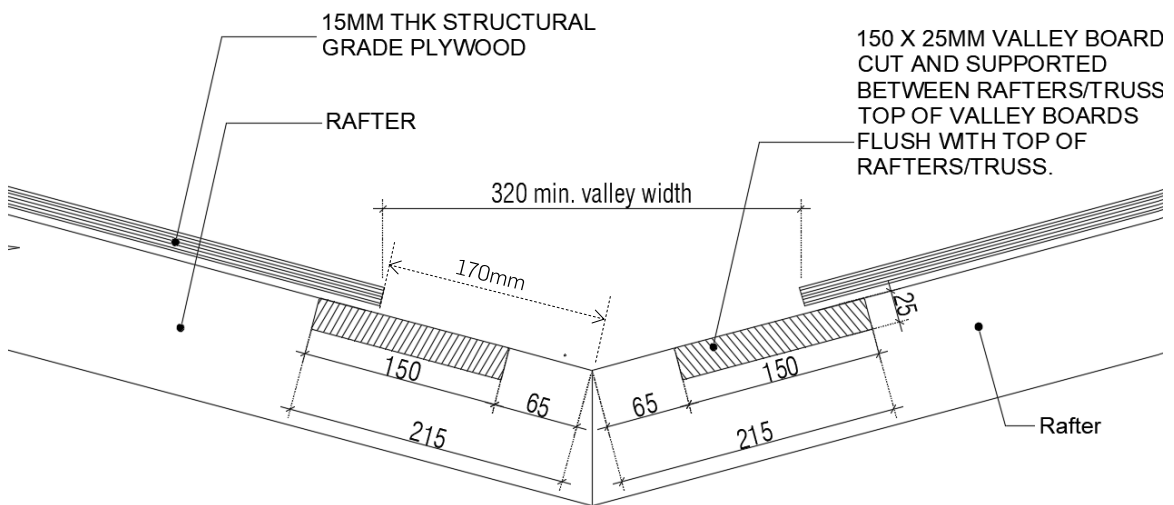

# CHIMNEY FRAMEWORK DETAIL

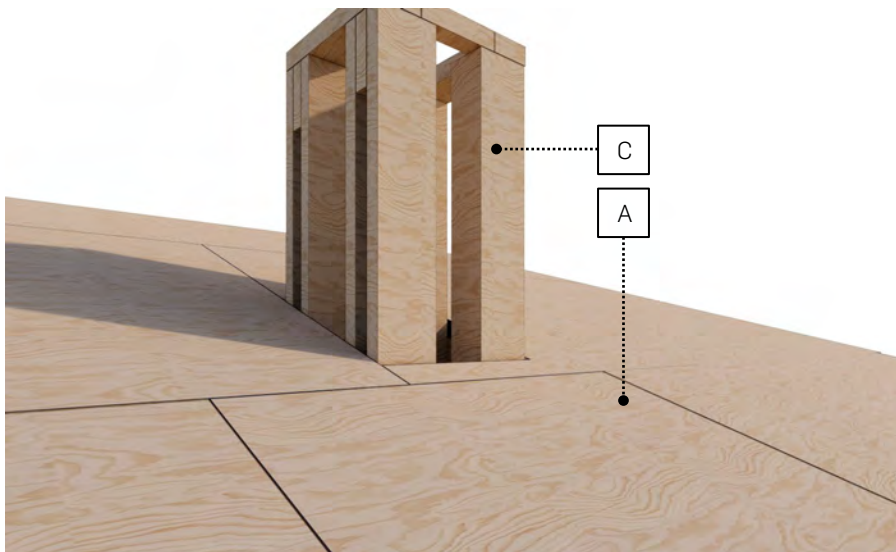
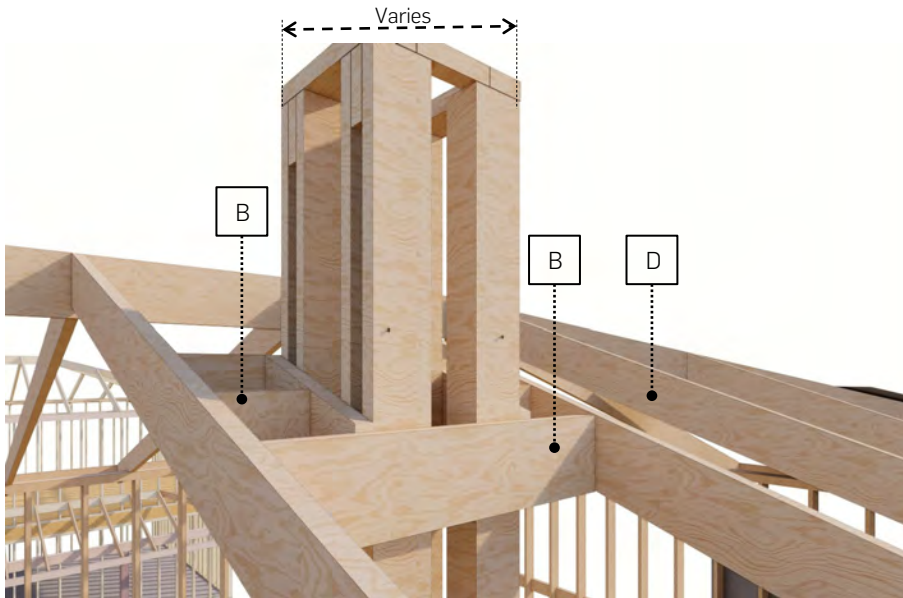

## COMPONENTS

- A. Structural grade 15mm thick plywood
- B. Support nog for chimney (actual design as per architect's detail/specification)
- C. Chimney framing (dimensions and design as per architect's detail/specification)
- D. Rafter

## SKYLIGHT FRAMEWORK DETAIL

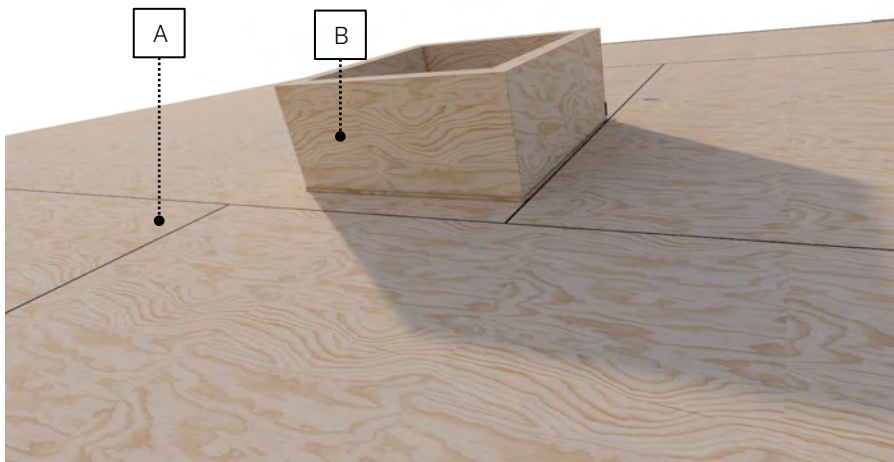
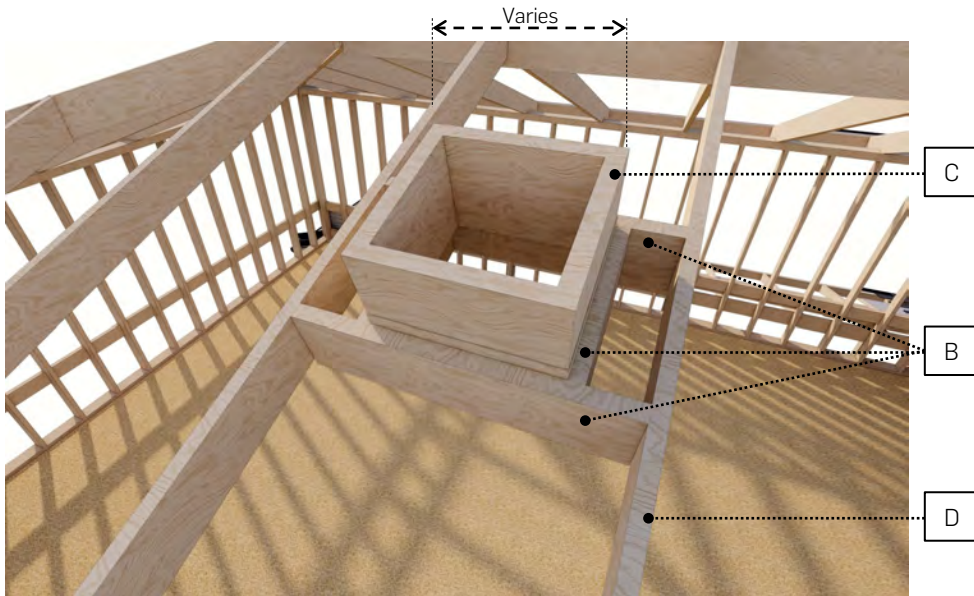

### COMPONENTS

- A. Structural grade 15mm thick plywood
- B. Support nog for skylight (actual design as per architect's detail/specification)
- C. Skylight curb/framing (dimensions and design as per architect's detail/specification)
- D. Rafter

# 03. EAVES INSTALLATION

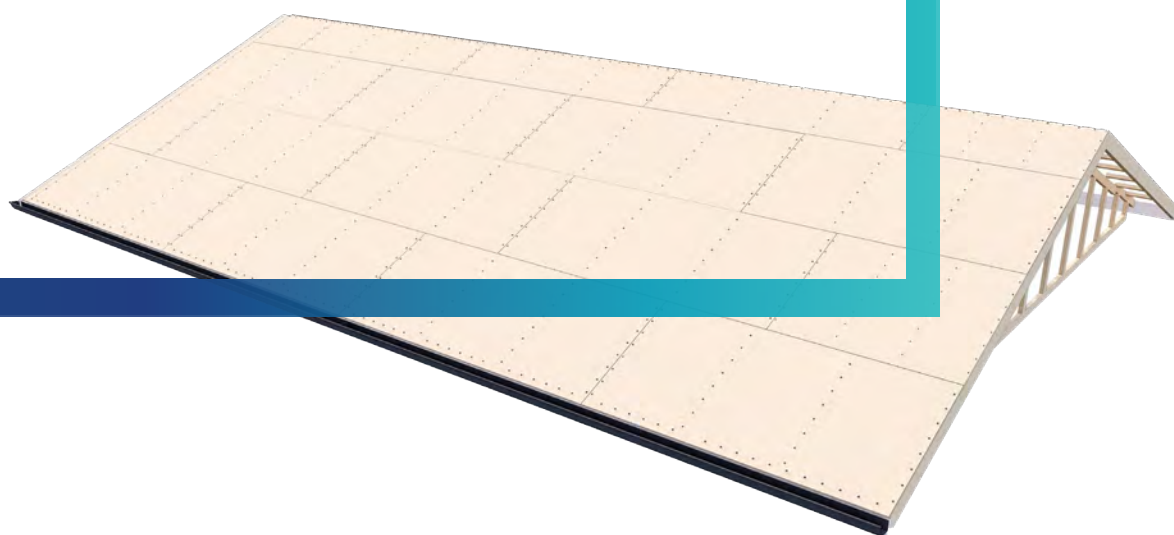

INSTALLATION MANUAL  
CALIBRE

# EAVES DETAIL

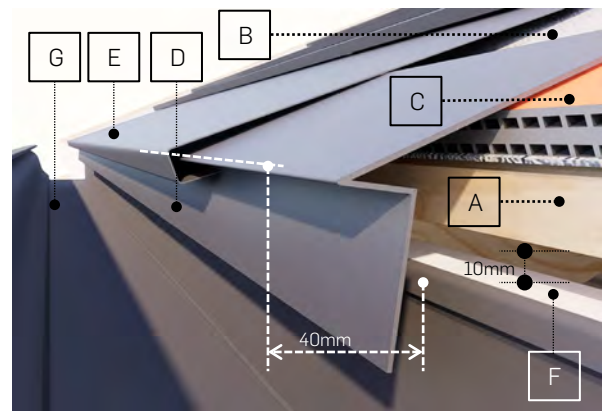
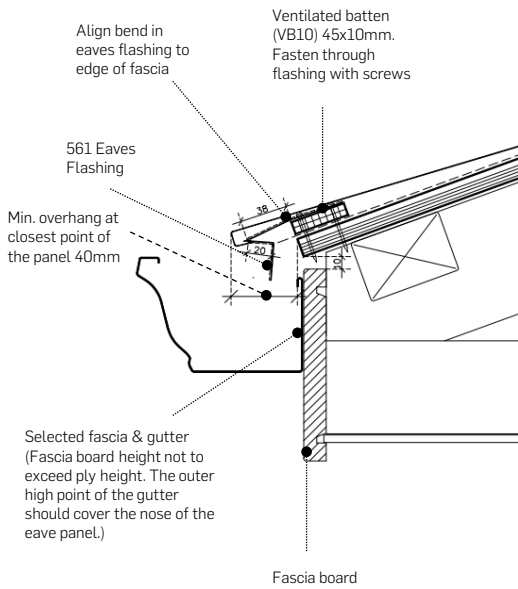
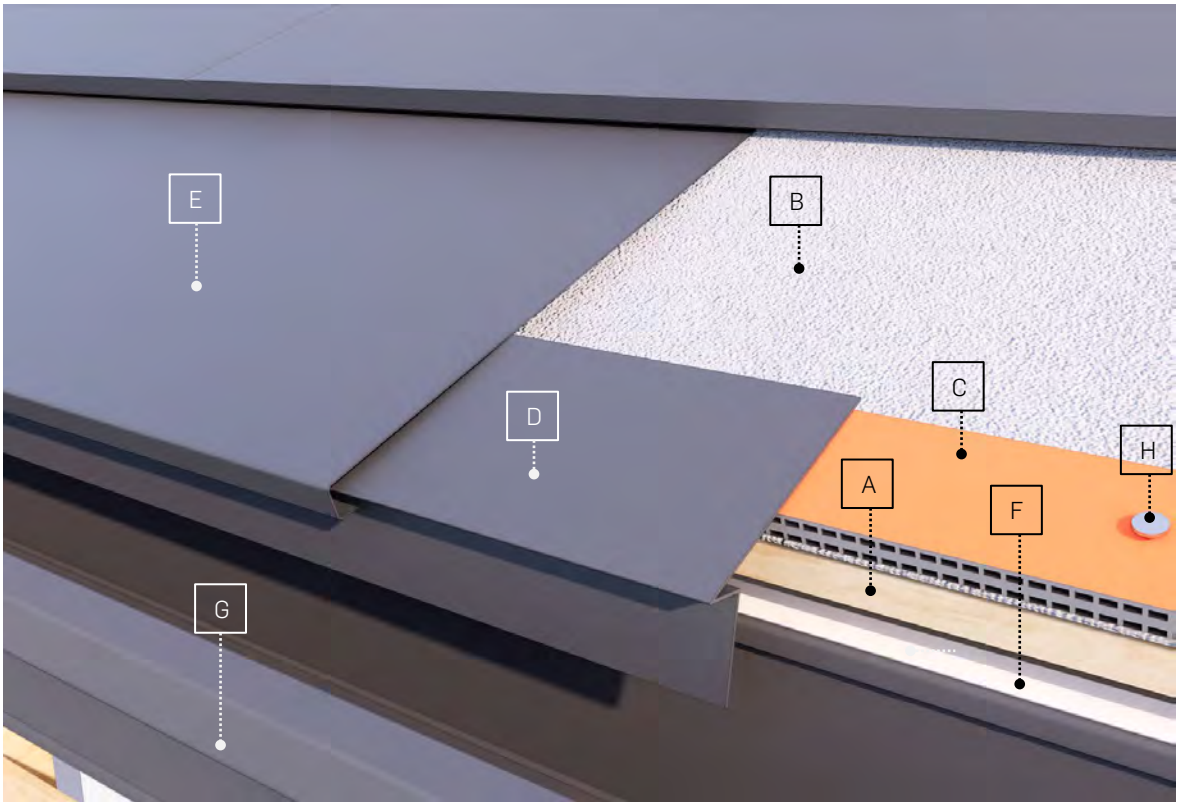

Color representation of ventilated batten

## COMPONENTS

- A. Structural grade 15mm thick plywood
- B. Synthetic underlay
- C. Ventilated roof batten
- D. 561 Eaves Flashing
- E. Calibre panel
- F. Fascia board
- G. Gutter
- H. Hex roof screw

# EAVES FLASHING INSTALLATION

## INSTALLATION

The builder should have installed the ply, ready for roofing.

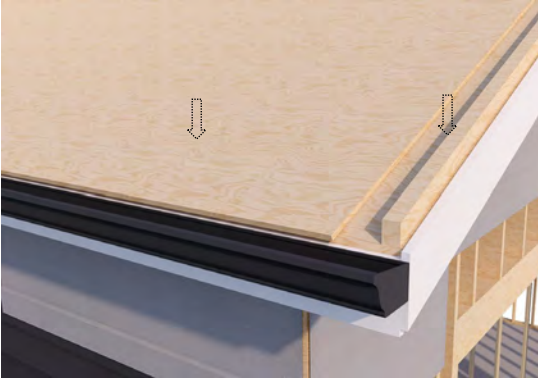

Install the underlay across the plane of the roof, then lay ventilated battens at the eave, flush to the edge of the ply. Fix the ventilated battens into the ply.

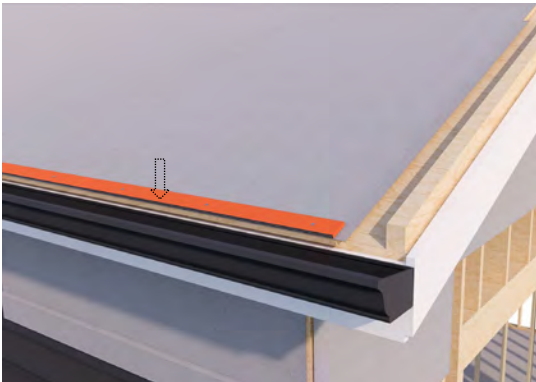

Position the 561 Eaves Flashing so there is a minimum of 40mm overhang from the fascia to the farthest point of the flashing. This can be achieved by aligning the bend in the eaves flashing with the edge of the fascia.

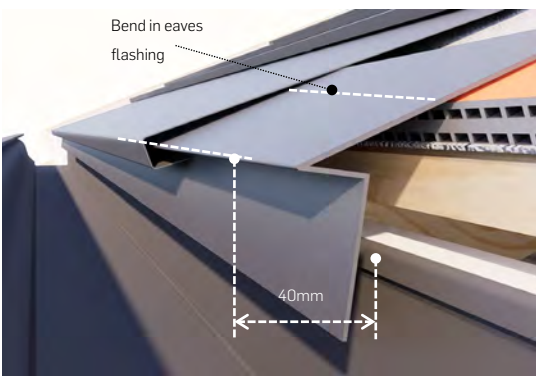

Fix through the ventilated battens into the ply substrate.

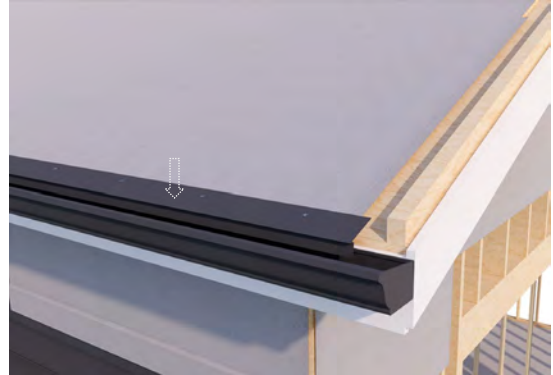



# 04. PANEL INSTALLATION

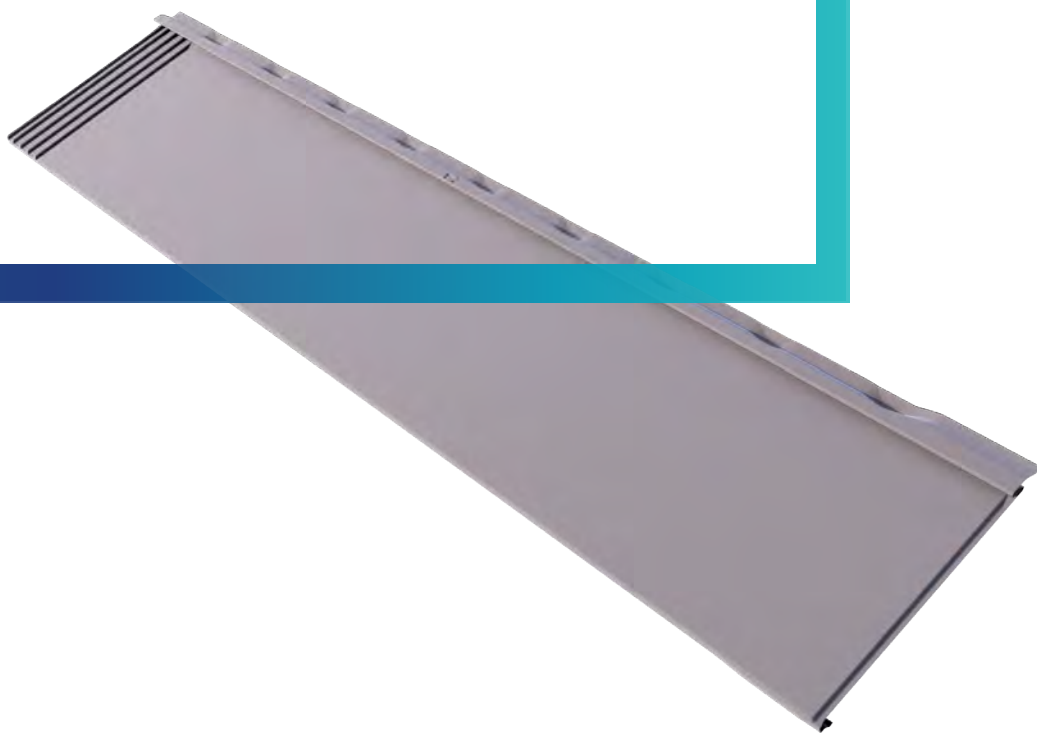

INSTALLATION MANUAL  
CALIBRE

# PANEL INSTALLATION

## METHOD

Hook the nose of the first panel to the already installed 561 Eaves Flashing.



Secure the panel with five fasteners evenly spaced at the head of the panel.

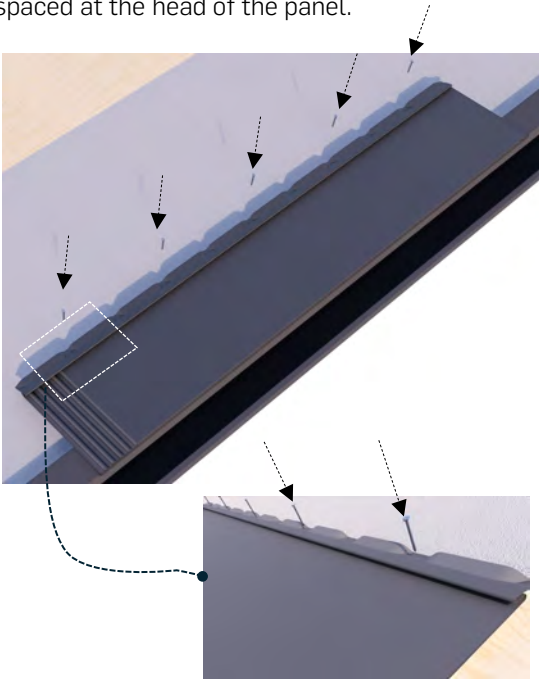

After installing the first panel, use the same method to fit the second panel over the first, overlapping at the weather channel. Push the panel upwards to secure in place, then fix with five fasteners.

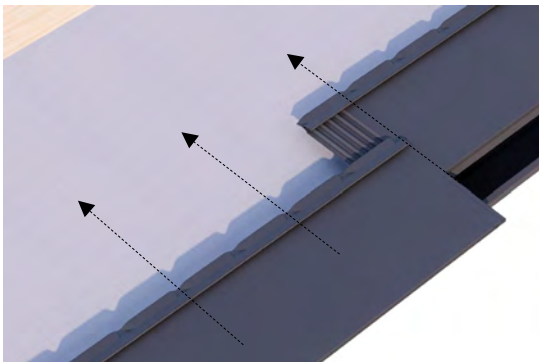

After installing the first course, fit the second course by hooking the nose of the second course panel into the rear head check. Use the arrow in the centre of the panel's head check to align the edge of the second course.

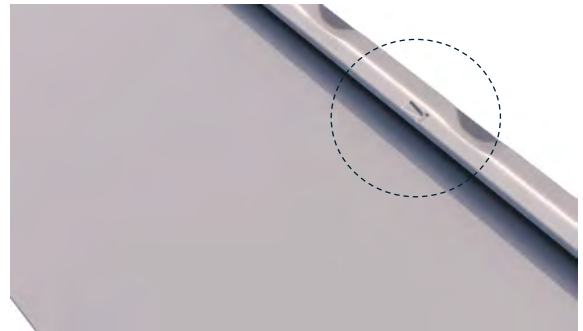

Push the panel upward to ensure full contact along the panel, then secure the panel with five fasteners. Repeat across and up the plane of the roof.

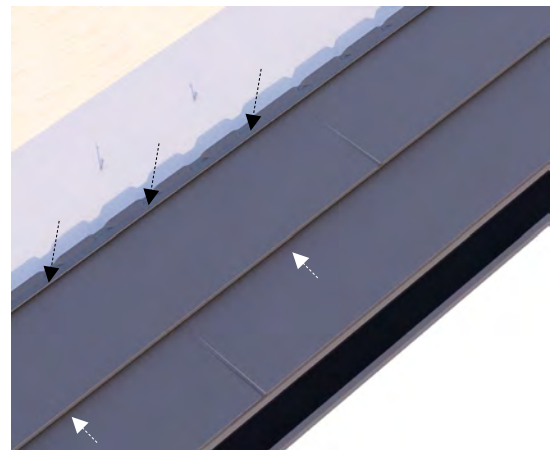

## UPSTAND

Turn up panels a minimum of 40mm at side walls and top course.

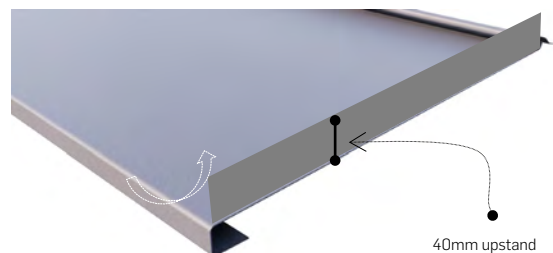

# COMMON CUT GUIDE

## SIDE BEND

Cutting correctly for side bends is critical as crushing will prevent the next course from being able to interlock into the head of the panel.

Measure your bend line from the edge of the panel nose and head. There should be a minimum of 40mm from the edge.

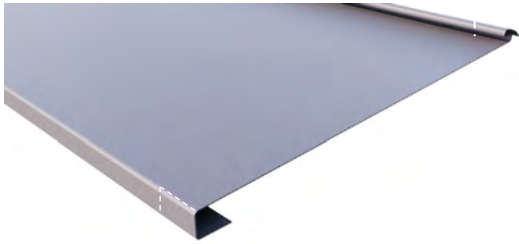

Cut the fold of the panel's nose, cutting the underside, then snip the fold off.

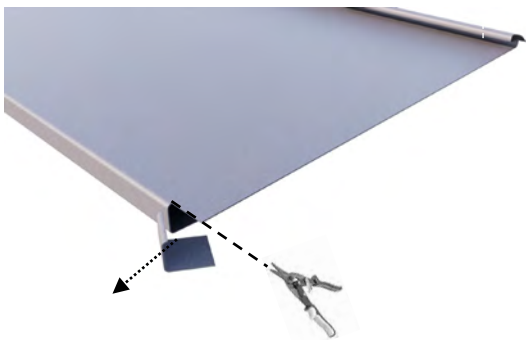

Cut the fold of the head of the panel, then snip the fold off.



Bend the side end of the panel to create a 40mm upstand.

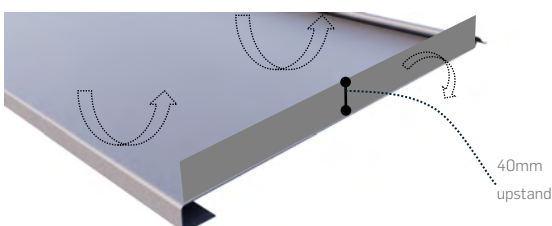

## HEAD BEND

Measure your bend line from the nose of the panel up to the head of the panel. Mark out your cut line and your bend line. Your bend line should be a minimum of 40mm from the cut line.

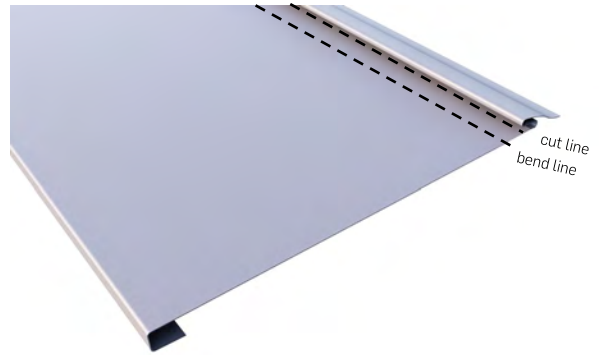

Cut your panel along the cut line. Then bend the head of the panel to create an upstand against the wall or support nog.

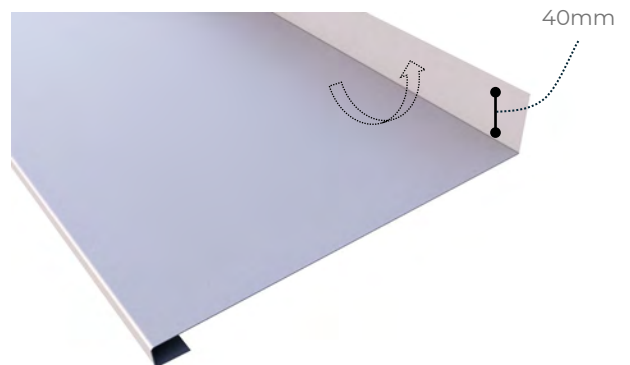
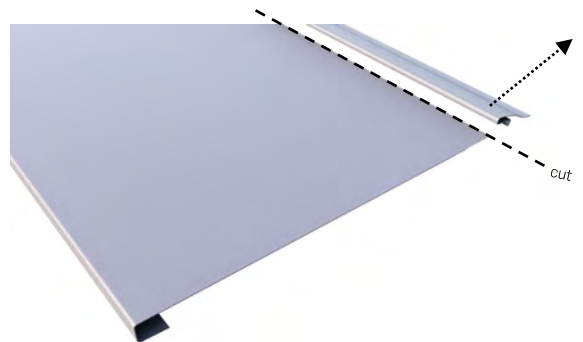

# COMMON CUT GUIDE

## PARTIAL END OVER VALLEY

### LEFT SIDE



Before installation, fit the cut panel piece into a full panel at the weather channel.

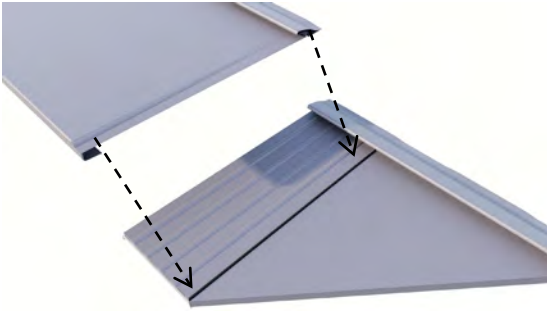

Rivet the panels together. Apply silicone to the rivets and finish with touch up paint.

Top view

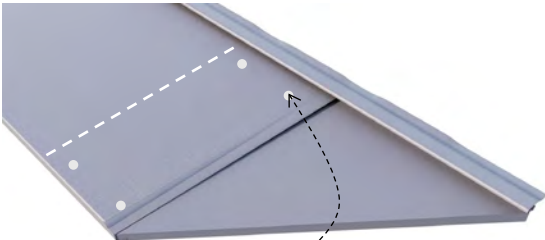

Rivet together, seal with silicone, and finish with touch up paint

Bottom view

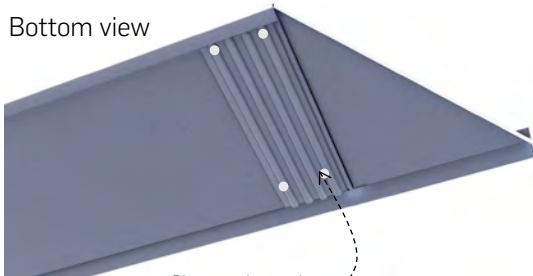

Rivet together, seal with silicone, and finish with touch up paint

### RIGHT SIDE



Mark a cut line and a bend line to the angle of the valley install. Cut the nose fold, then cut along the cut line.



Fold down along the fold line.

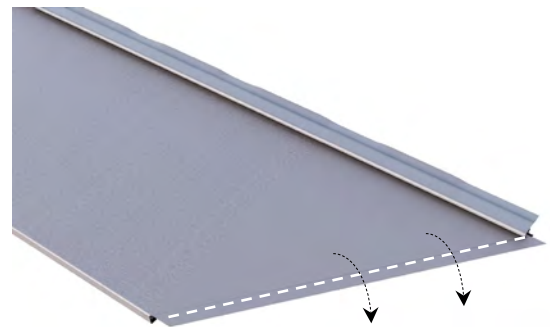

# SHORT COURSE INSTALLATION

## METHOD

Prepare your roof area by installing underlay, fascia, gutter, barge channel, and eaves flashing. Install full roof panels up to the change in roof eaves.

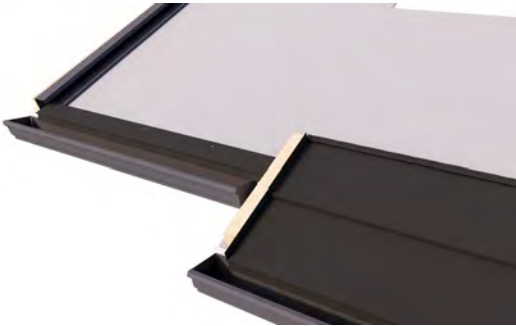

Install the panels on the short face, ensuring a turn up of minimum 40mm at the batten. Install a backflashing behind the batten.

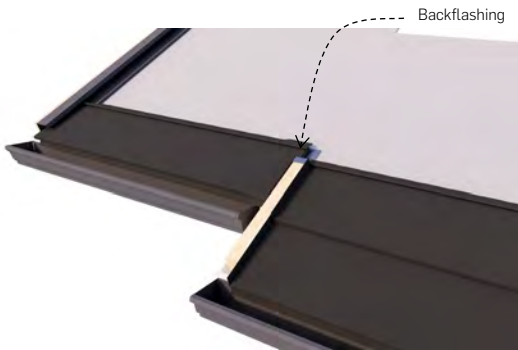

Fasten the shortcourse flashing in place, in alignment with the head check of the already-installed panels.

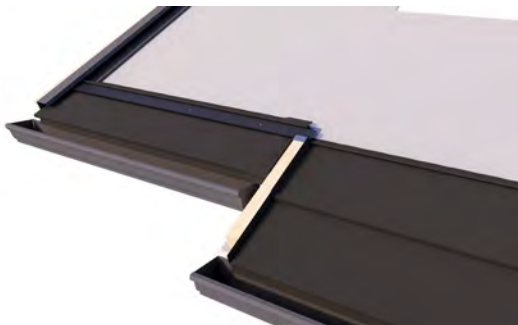

Install the second course of panels.

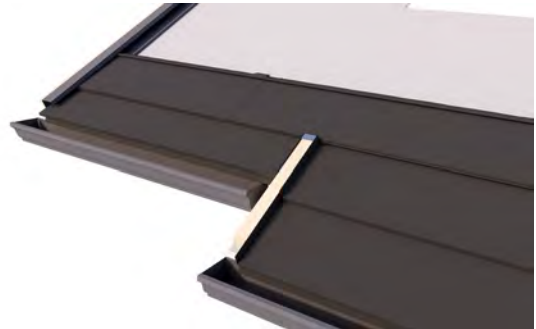

Install the rest of the panels and then install the barge covers. At the change in roof eaves, ensure the barge cover has the top edge turned down.

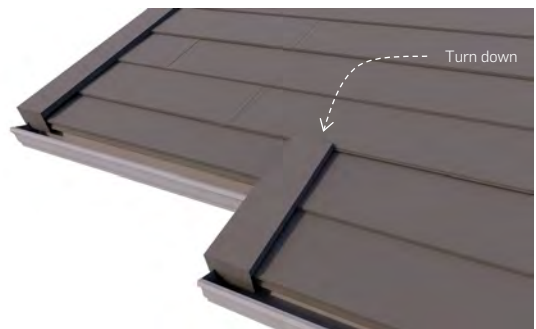
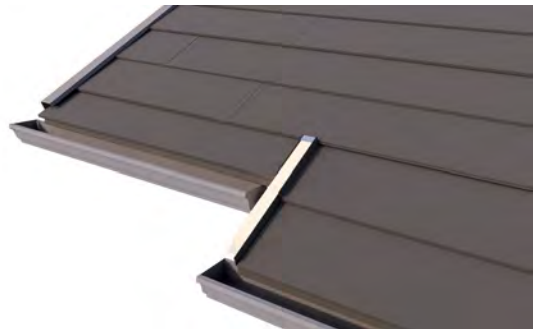

# 05. AREA SPECIFIC DETAILS

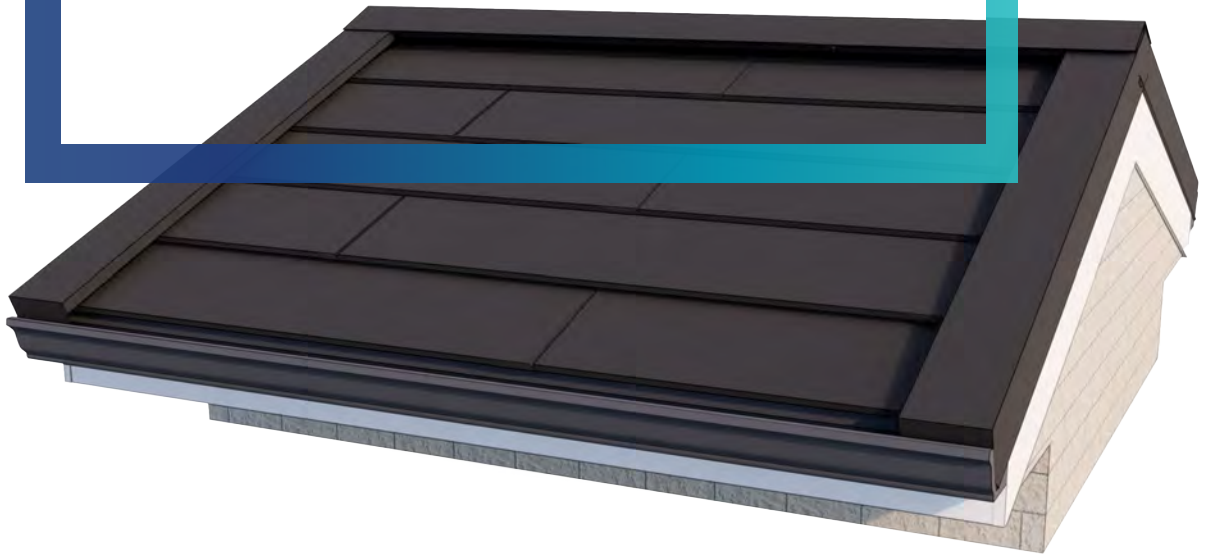

INSTALLATION MANUAL  
CALIBRE

 **GERARD**  
Roofing Designed to Endure

# RIDGE DETAIL

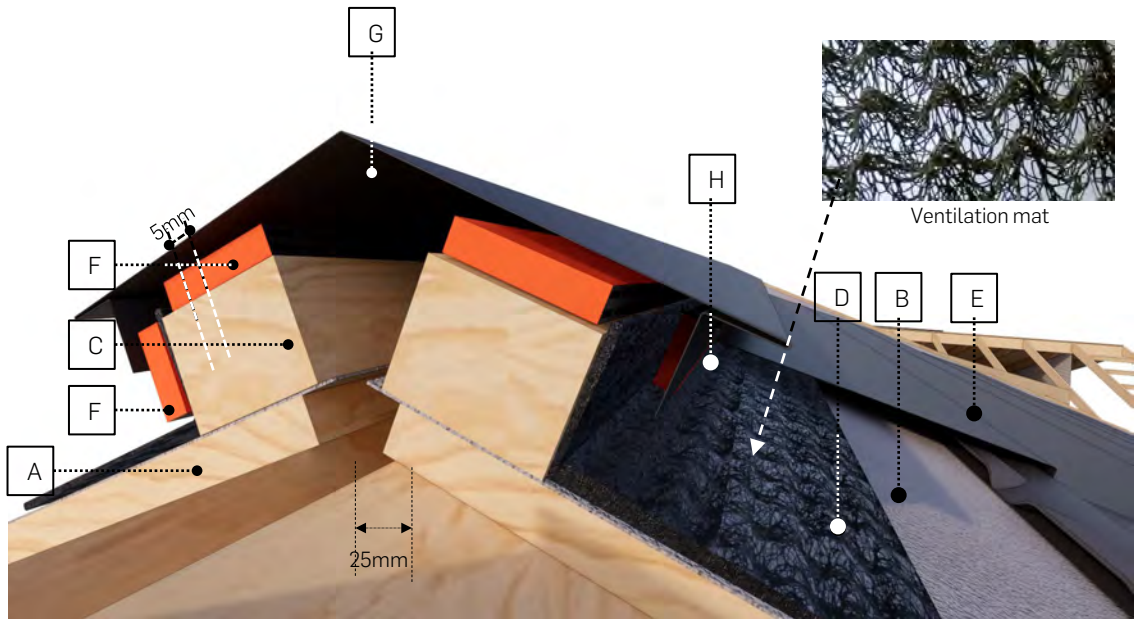

## COMPONENTS

- |  |                        |
|--|------------------------|
| A. Structural grade 15mm thick plywood | E. Calibre panel       |
| B. Synthetic underlay                  | F. Ventilation batten  |
| C. 40x50mm batten                      | G. 550 Long Angle Trim |
| D. Ventilation mat                     | H. Hex roof screw      |

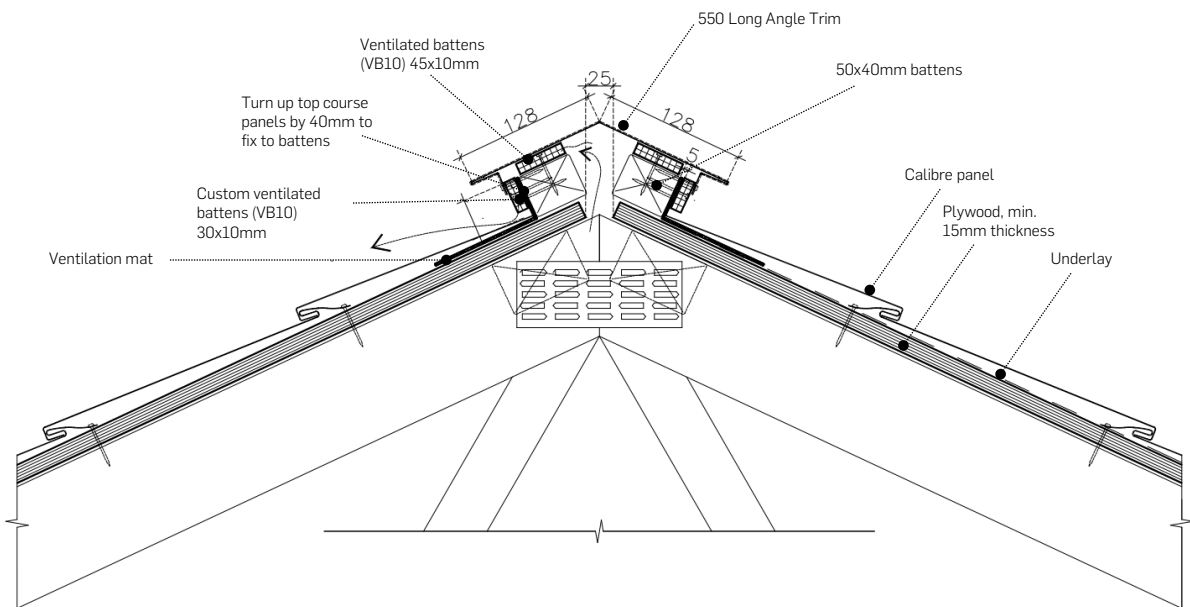

 Color representation of ventilated batten

# RIDGE INSTALLATION

## PREPARATION

Fix your underlay on top of the ply. Ensure there is a gap at the ridge between the two planes of the roof.

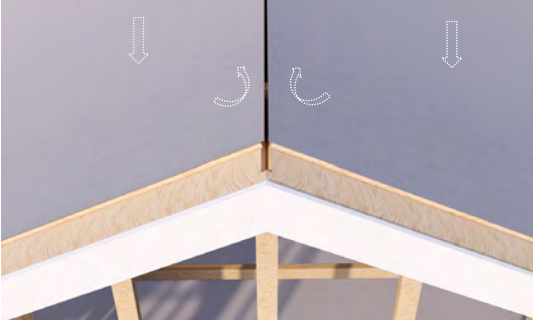

Install 40x50mm battens along the ridge, leaving a 25mm gap between them to allow for airflow.

Install 40x50mm battens along the fascias following the instructions in the Barge Installation section.



Install the barge channels.



Install ventilated battens to the top of the ridge battens.

10mm from the top of the batten, apply the ventilation mat.



Install Calibre panels up the roof, turning up the panels at the ridge.

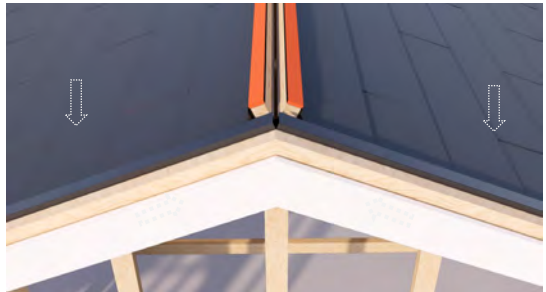

Cut down VB10 ventilated battens to 30x10mm and install on the outside of the ridge battens.



Install the barge covers, then install 550 Long Angle Trim over the ridge.





## RIDGE INSTALLATION

### CUTTING FOR A GABLE END

Measure the depth of the barge cover at the gable end. Use this measurement to mark a cut line on the struts of the angle trim.



Cut up the struts at the cut line, then make a horizontal cut to remove the flap. Repeat on both sides.

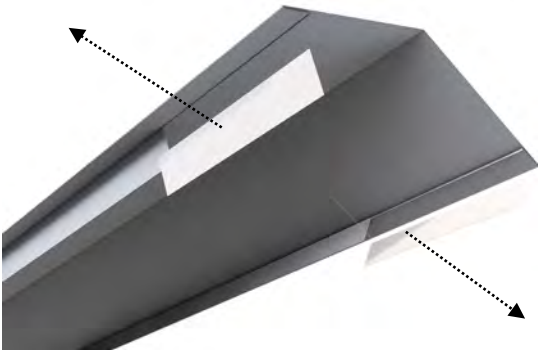

This allows clearance to fit the angle trim over the top of the installed barge covers. Once fitted, screw into the battens horizontally into the struts.

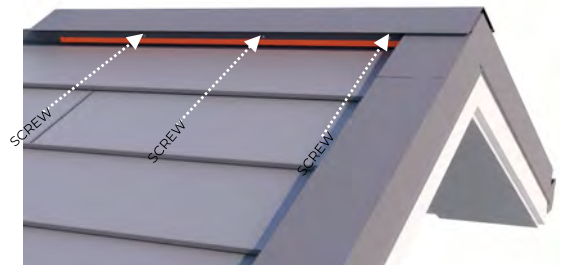
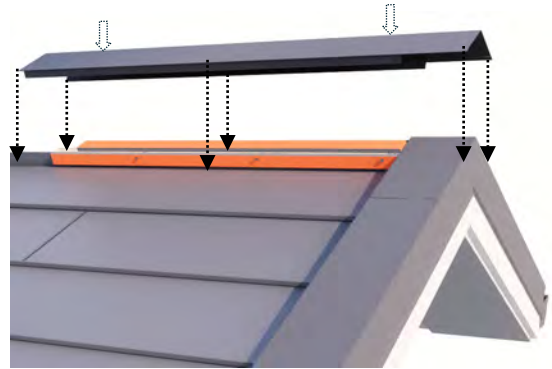

### OVERLAPPING TRIMS

Angle trims should overlap by a minimum of 100mm.

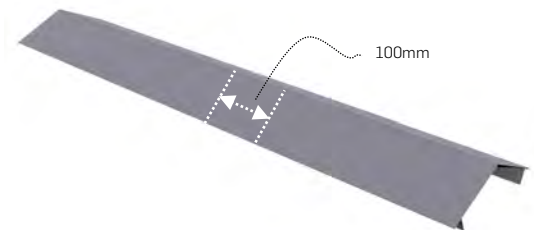

# HIP DETAIL

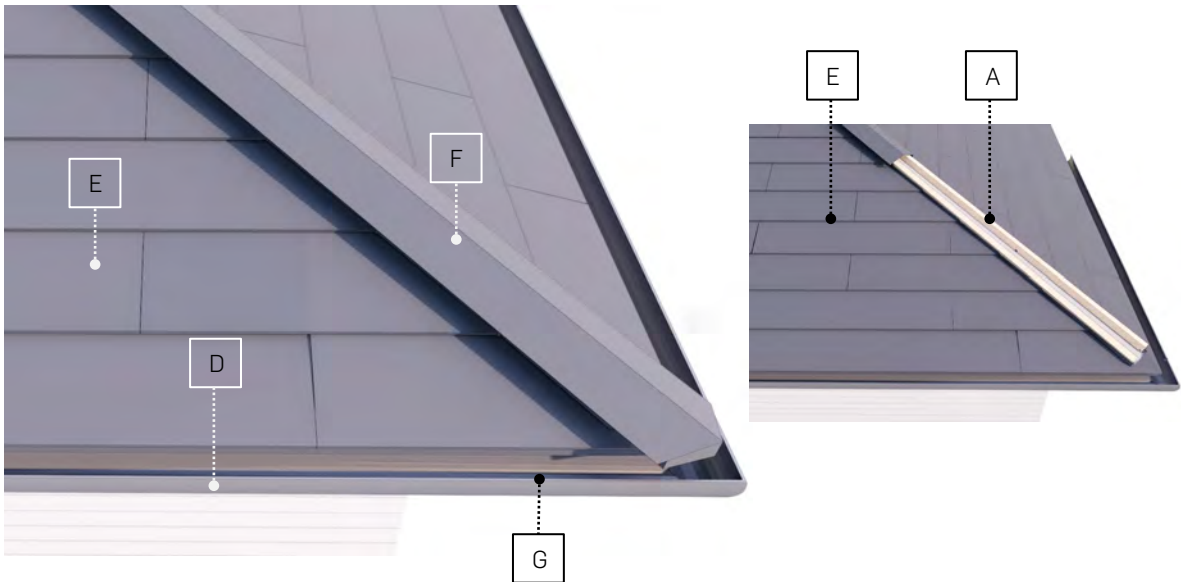

## COMPONENTS

- |  |                        |
|--|------------------------|
| A. Structural grade 15mm thick plywood | D. Fascia board        |
| B. 50x40mm batten                      | E. Calibre panel       |
| C. Synthetic underlay                  | F. 550 Long Angle Trim |
|  | G. Gutter              |

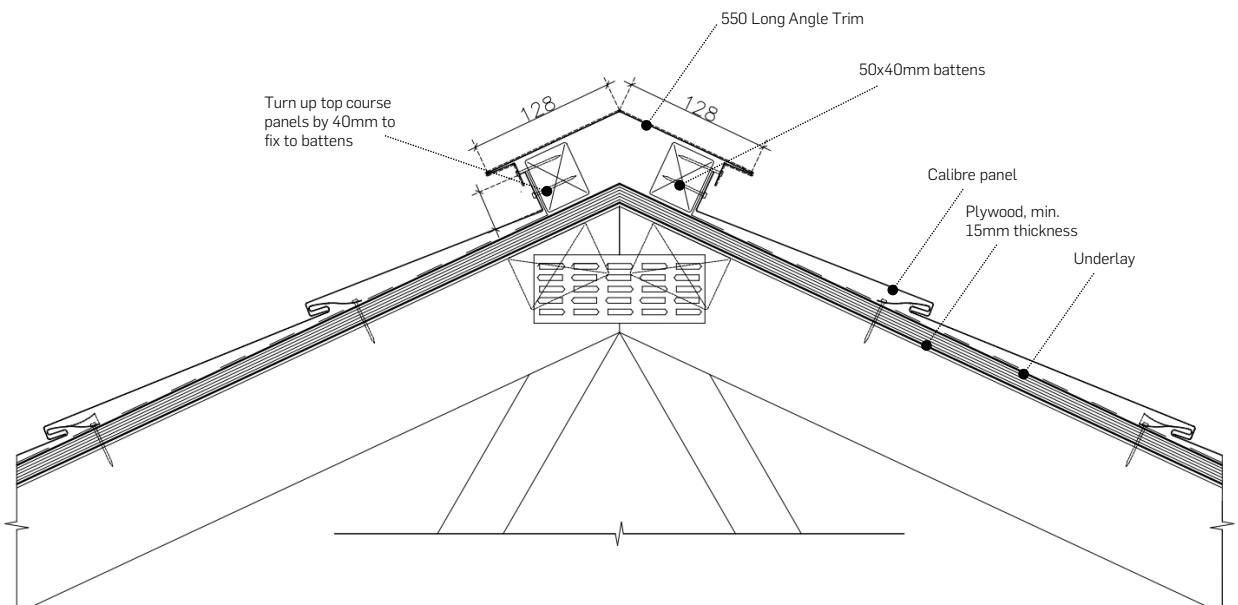

# HIP INSTALLATION

## SETTING OUT

Lay out your underlay and install ventilated battens and eaves flashings as instructed in the Eaves Flashing section.

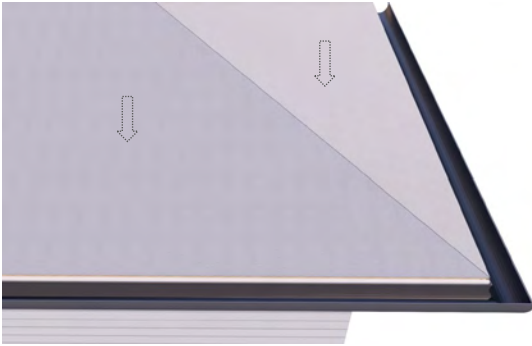

Fix two battens running up either side of the hip with 54mm spacing between them.

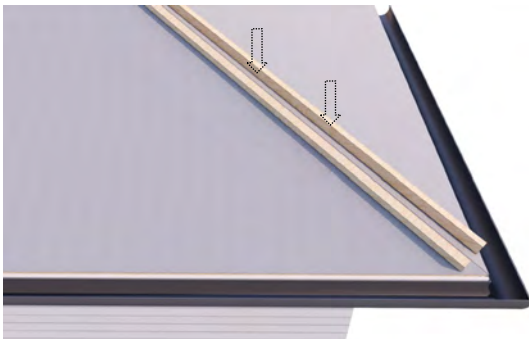
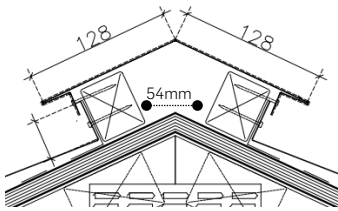

## INSTALLATION

Install your panels, starting at the eaves. When you reach the battens create an upstand of a minimum of 40mm.



Install trim, fixing with horizontally applied fasteners through the trim's struts.



# TRIM INSTALLATION

## CUTTING AND FOLDING

Prepare your first trim for installation. Using a 550 Long Angle Trim, cut the fold of the nose off. Then cut the in the middle, slightly off-centre, and on the sides of the nose.

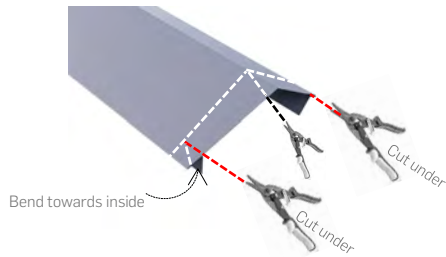

Fold the top down, overlapping the centre point to create a clean front.

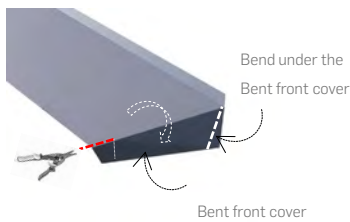

Fold in the edges if required. Trim off excess if required.

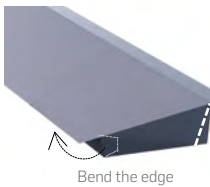

## INSTALLATION - HIP

Cut and fold the first trim to fit into the corner of the roof.



Fasten into the hip batten with fasteners horizontally in the struts of the trim.



# VALLEY DETAIL – USING VALLEY COVER

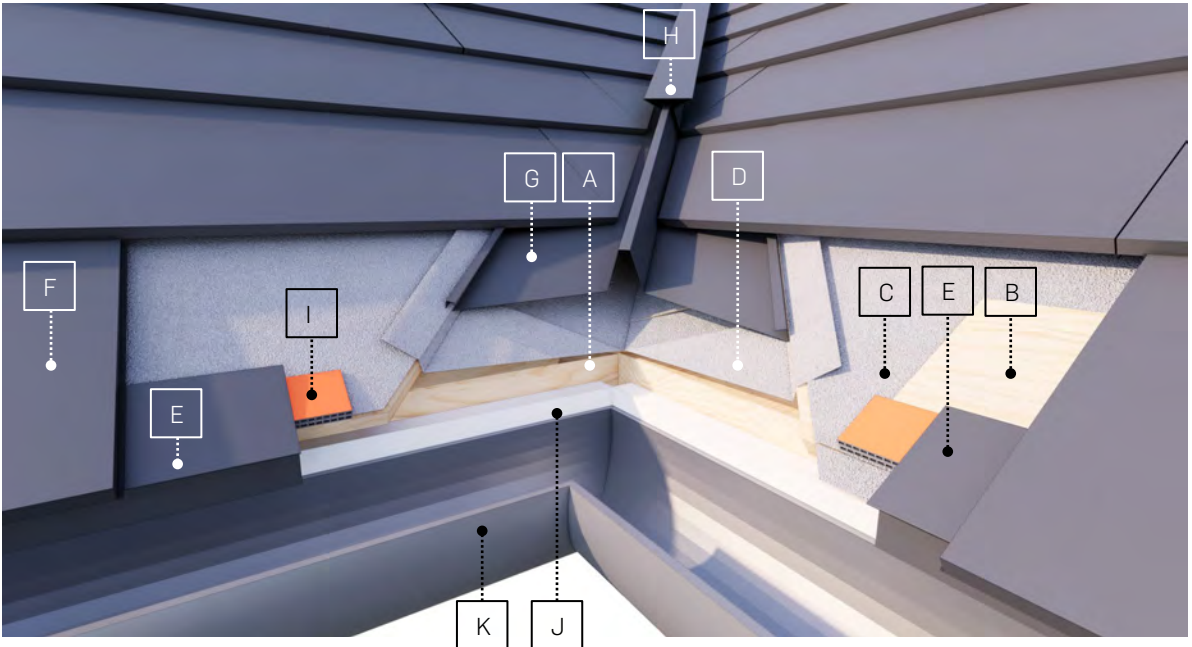

## COMPONENTS

- A. Valley board
- B. Structural grade 15mm thick plywood
- C. Synthetic underlay
- D. Synthetic underlay
- E. 561 Eaves Flashing
- F. Calibre panel
- G. 553 Valley
- H. 554 Valley Cover
- I. Ventilated battens
- J. Fascia board gutter

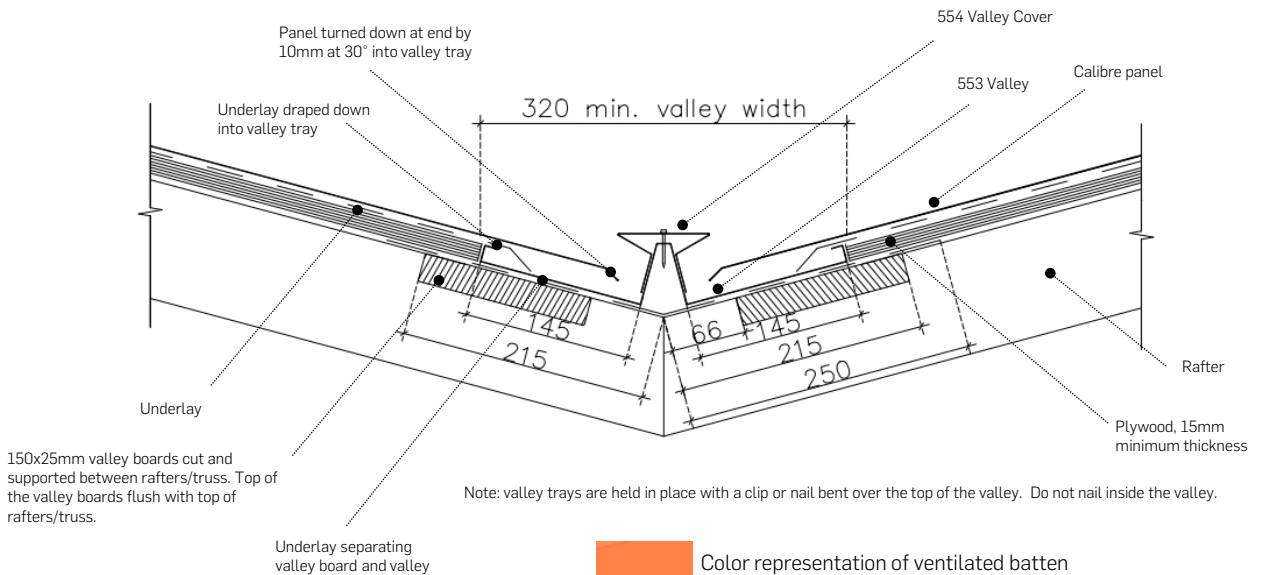

# VALLEY DETAIL – WITHOUT VALLEY COVER

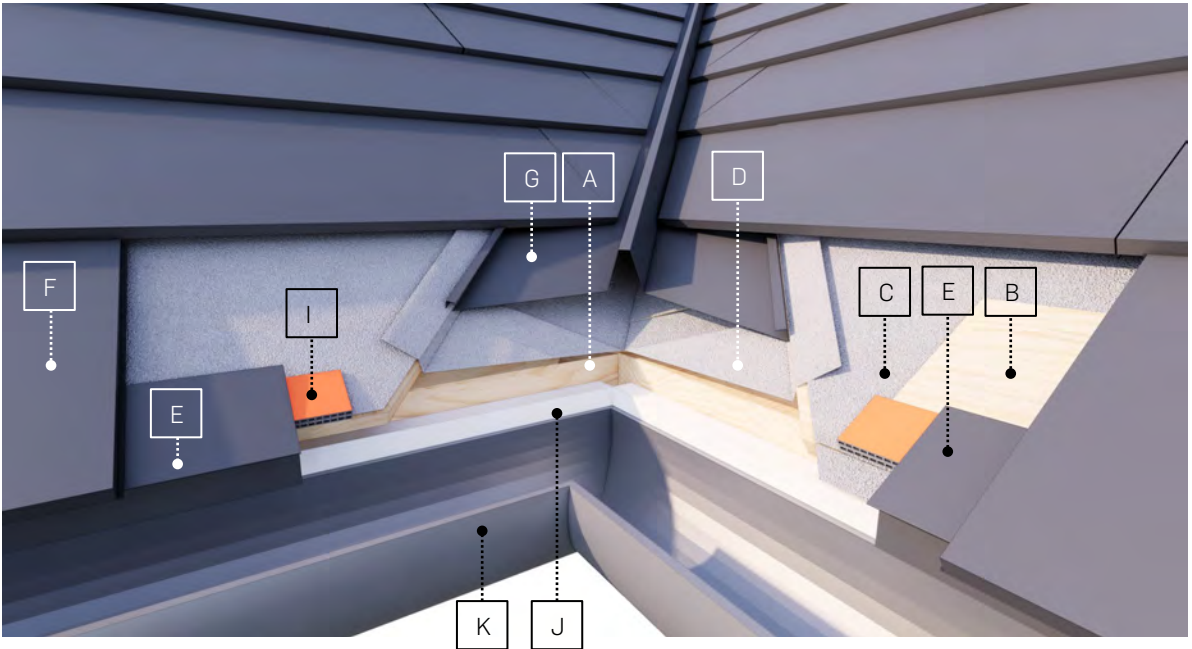

## COMPONENTS

- A. Valley board
- B. Structural grade 15mm thick plywood
- C. Synthetic underlay
- D. Synthetic underlay
- E. 561 Eaves Flashing
- F. Calibre panel
- G. 553 Valley
- H. 554 Valley Cover
- I. Ventilated battens
- J. Fascia board
- K. Gutter

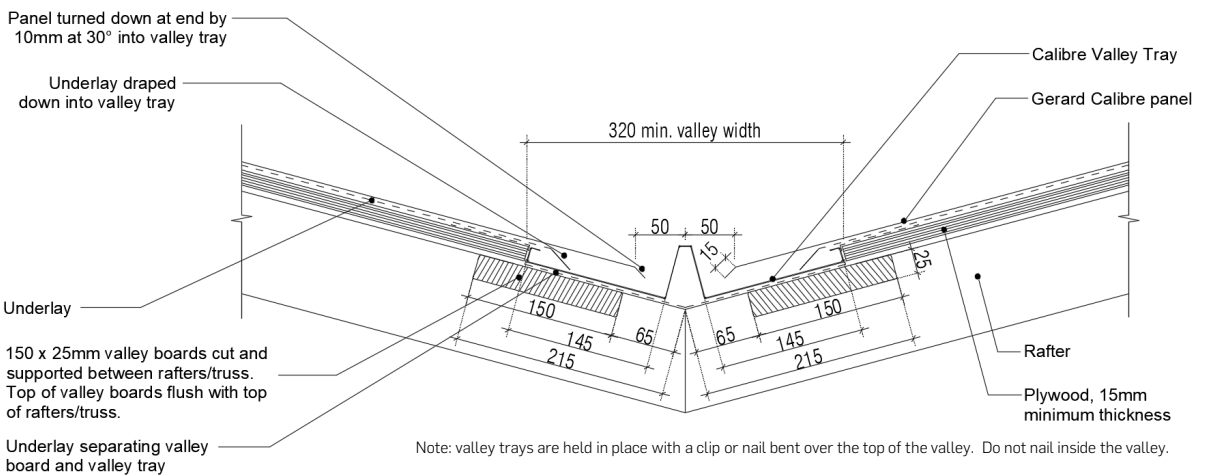
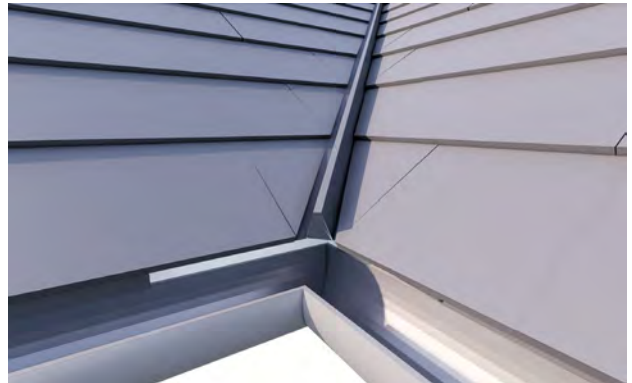

 Color representation of ventilated batten

# VALLEY INSTALLATION

## PREPARATION

Once the valley boards and ply are installed by the builder, lay underlay under the valley section.

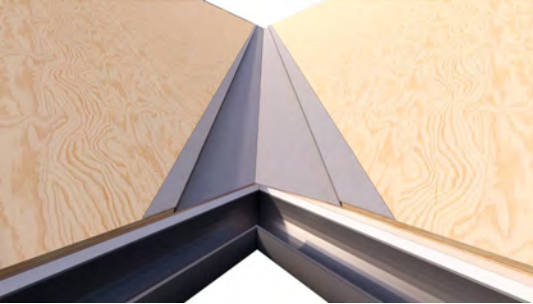

## INSTALLATION

Prepare the first 553 Valley by cutting and folding the edge to turn down into the gutter. The valley should be positioned a minimum of 40mm from the edge of the fascia for sufficient overhang.

Use a nail secure the valley into place. Ensure you do not penetrate the valley. Bend nails over the rail, rather than penetrating through the valley.

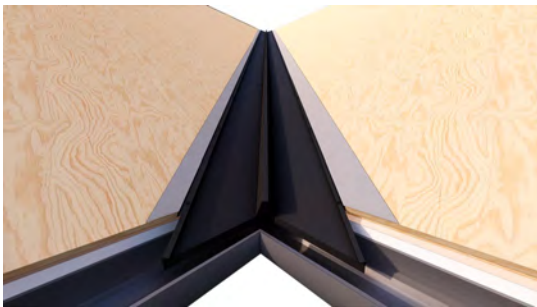

Slide the second valley tray into the first. Add silicone between the trays, across the entire width. The valley trays should overlap by 150mm.

Install underlay across the plane of the roof, with a slight overhang draping into the valley. Install ventilated battens and eaves flashings at the eaves according to instructions in the Eaves Flashings section.

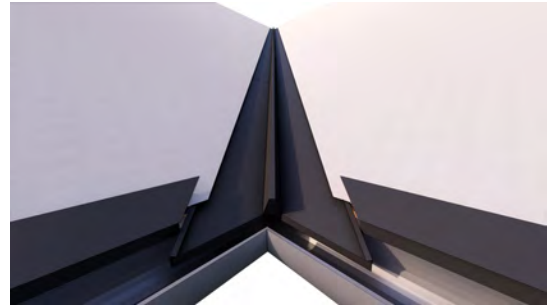
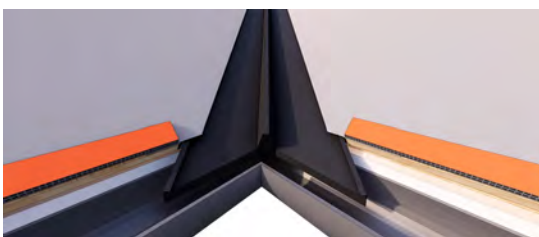

Install Calibre panels up the roof, starting at the eaves. Ensure there is a minimum of 80mm space between the panels on opposing sides of the valley (100mm if not using a valley cover). When the valley is reached, create a 10mm turn down into the valley at a 30-degree angle.



## VALLEY COVER

If using a valley cover, install the 554 Valley Cover, fastening to the valley through the centre and sealing with silicone.



# SPILL OUT VALLEY DETAIL

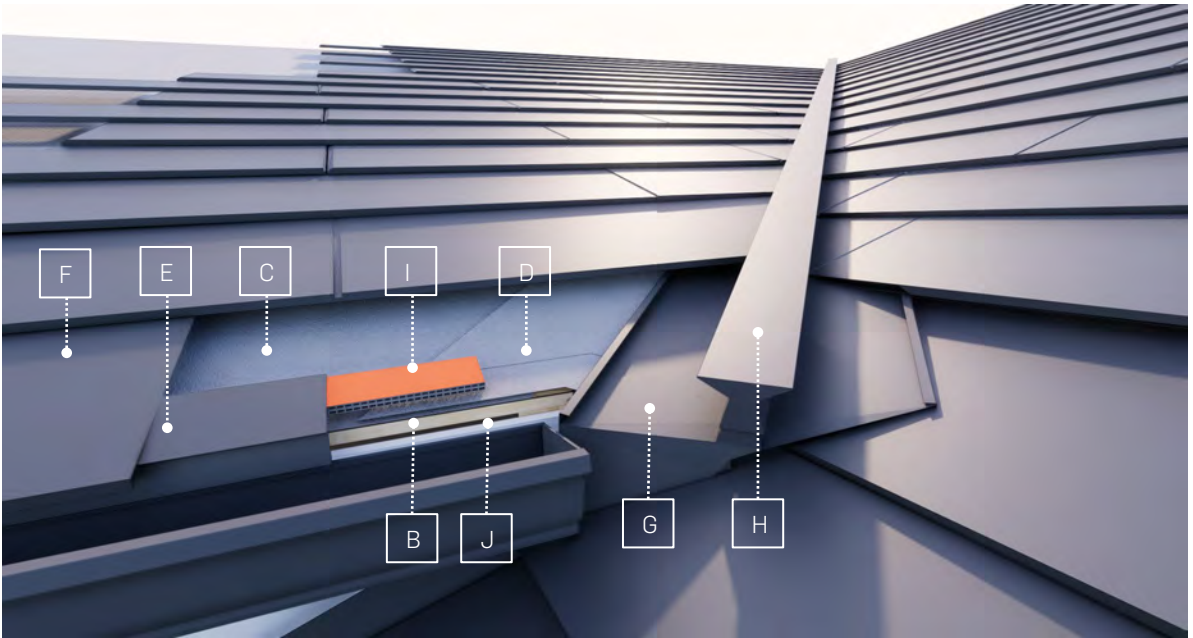

## COMPONENTS

- A. Valley board
- B. Structural grade 15mm thick plywood
- C. Synthetic underlay
- D. Synthetic underlay
- E. 561 Eaves Flashing
- F. Calibre panel
- G. 553 Valley
- H. 554 Valley Cover
- I. Ventilated battens
- J. Fascia board
- K. Gutter

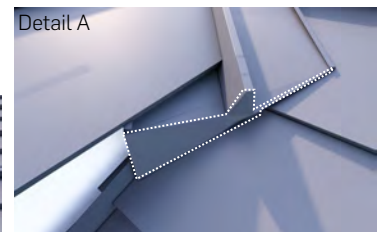
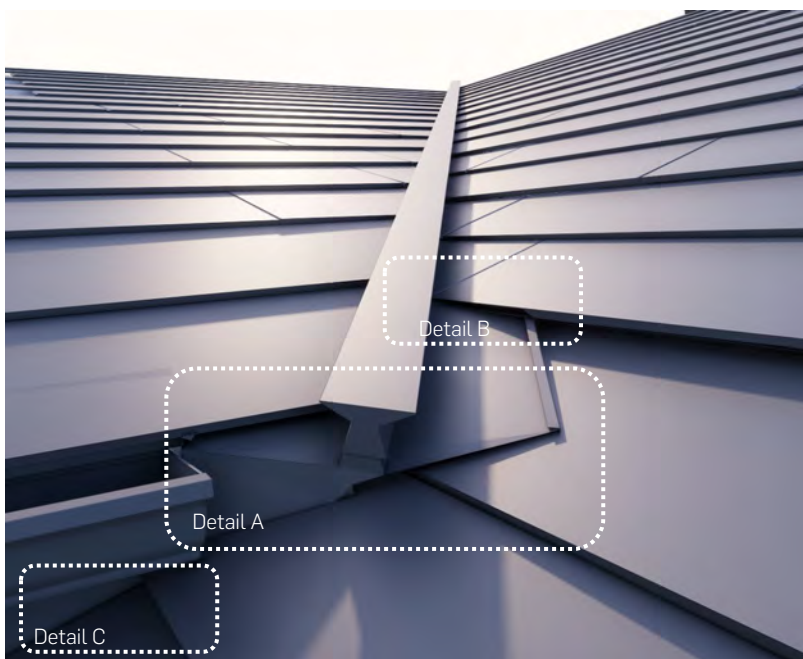

Cut and fold valley edge to cover the end of the tray

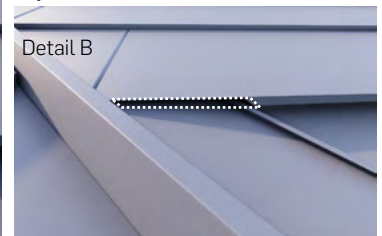

Cut the tip of Calibre panel end nosing to create a water spill out access

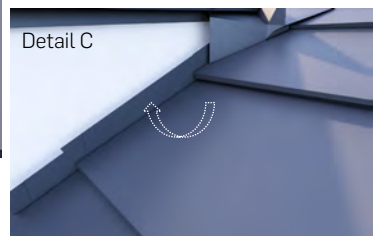

40mm turn up against side wall



# SPILL OUT VALLEY INSTALLATION

## INSTALLATION

Once the valley boards and ply are installed by the builder, review the spill over area. If the lower ply sits above the valley boards, trim it down.

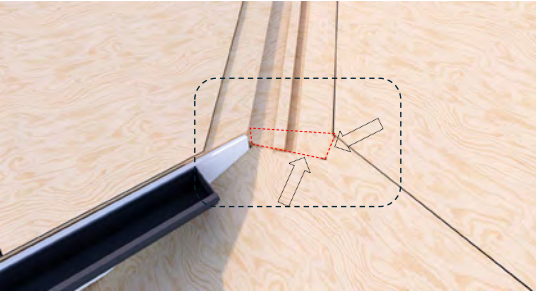

Install underlay across the roof, then lay another piece of underlay over the valley boards.



Install ventilated battens and eaves flashings at the eaves according to instructions in the Eaves Flashings section.



Install Calibre panels up the bottom section of the roof, stopping when one panel lays on top of the valley boards.



Prepare the 553 Valley by cutting and folding the end down to cover the exposed end.

Using a nail secure the valley into place. Ensure you do not penetrate the valley by bending nails over the rail, rather than penetrating through the valley.

Slide the second valley tray into the first. Add silicone between the trays, across the entire width. The valley trays should overlap by 150mm.



Install Calibre panels up the planes of the roof, leaving 80mm between panels on either side of the valley.

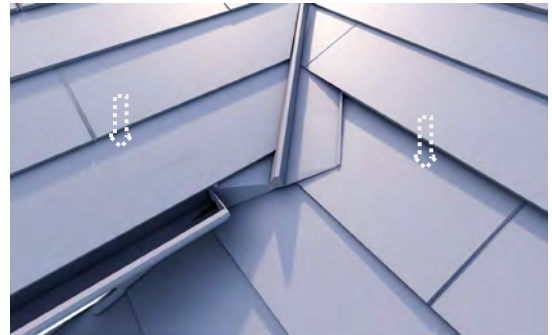

Install the 554 Valley Cover, fastening to the valley through the centre and sealing with silicone.



# BARGE DETAIL

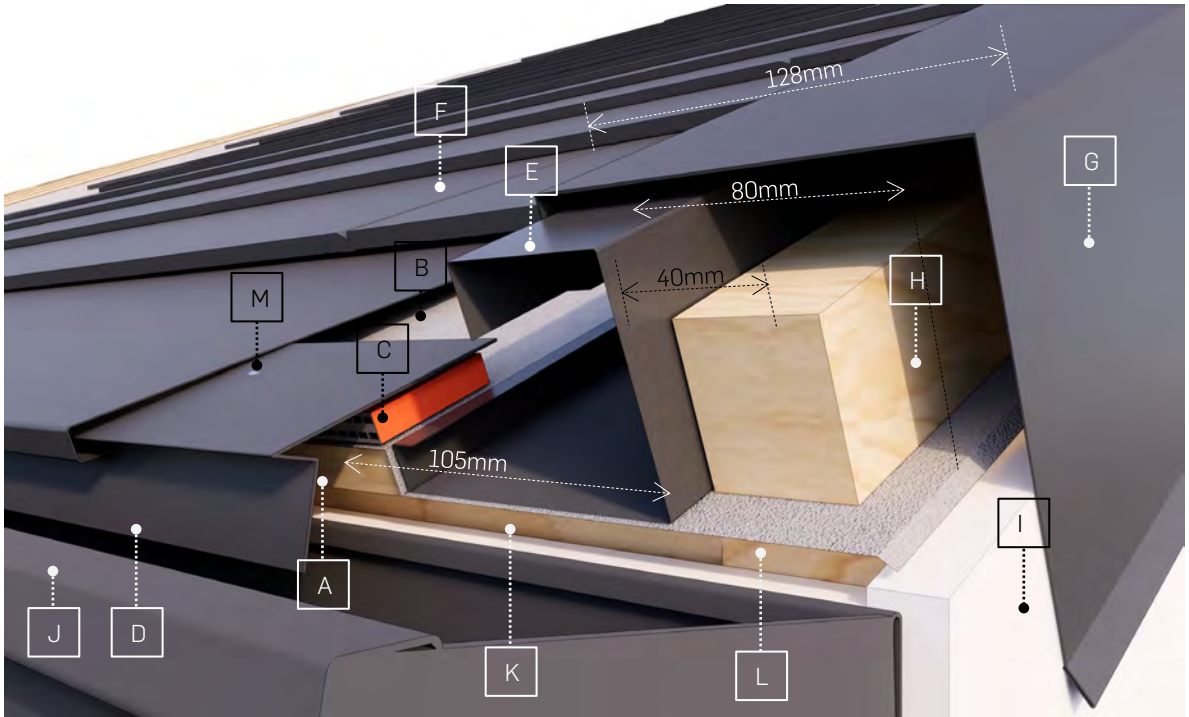

## COMPONENTS

- A. Structural grade 15mm thick plywood
- B. Synthetic underlay
- C. Ventilated roof batten
- D. 561 Eaves Flashing
- E. 556 Barge Channel
- F. Calibre panel
- G. 551 Barge Cover
- H. 50x40mm batten
- I. Fascia
- J. Gutter
- K. Barge support nog
- L. Flying rafter
- M. Hex roof screw

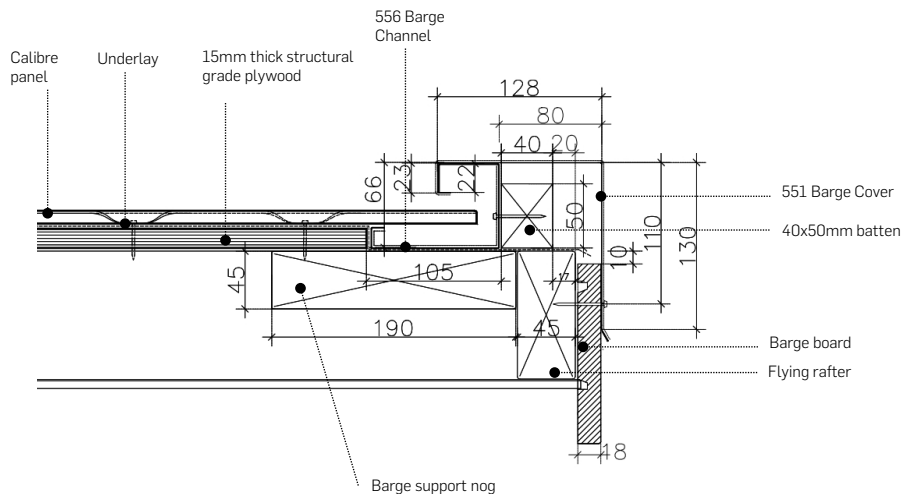
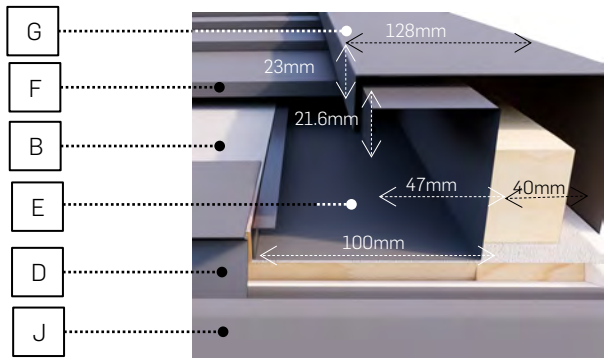

Color representation of ventilated batten

# BARGE INSTALLATION

## CUTTING AN END

Measure 55mm (approx.) from the front of the barge cover. Cut up the long edge of the cover and the opposing side

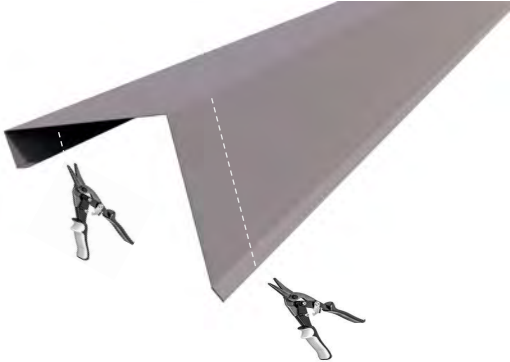

Make a horizontal cut to remove the bottom half of the newly-created flap.

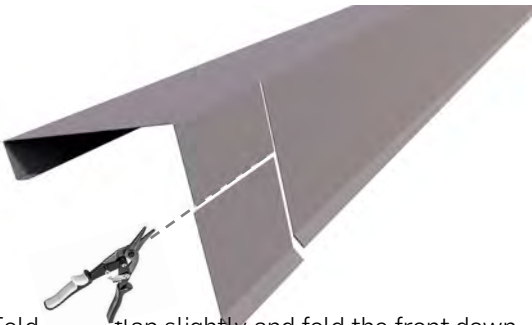

Fold down the flap slightly and fold the front down creating a box-end.

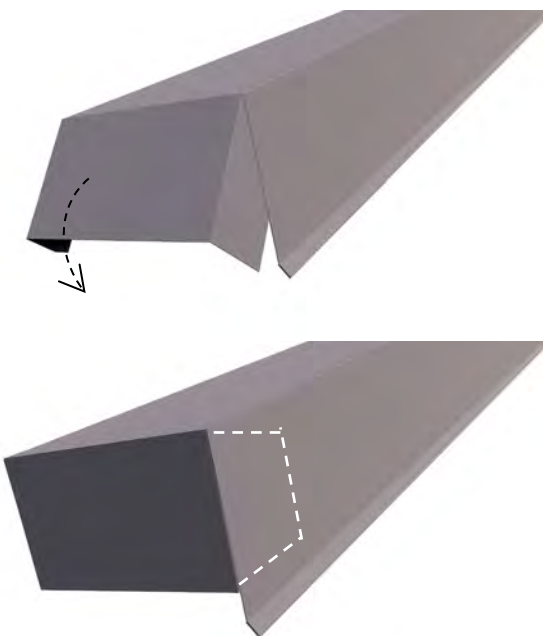

## NOTCHING – BARGE CHANNEL

Notch the barge channel by cutting 100mm up the side of the top and cut it off. This makes it easy to fit subsequent pieces into already installed barge channel pieces.

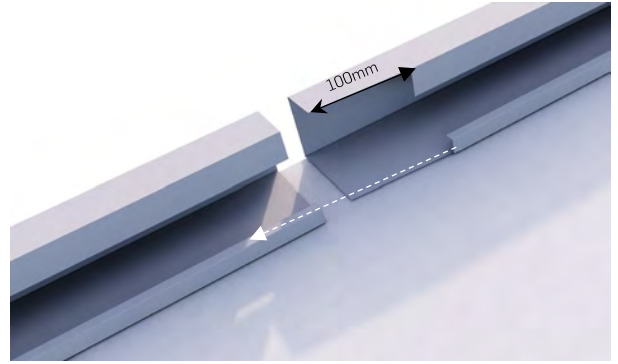

Side section

## NOTCHING – BARGE COVER

Cut a 100mm notch from the end of the barge cover. Cut off the excess from the notch. This makes it easy to fit subsequent pieces into already installed barge cover pieces.

Slide inside the first barge cover with an overlap of 100mm.

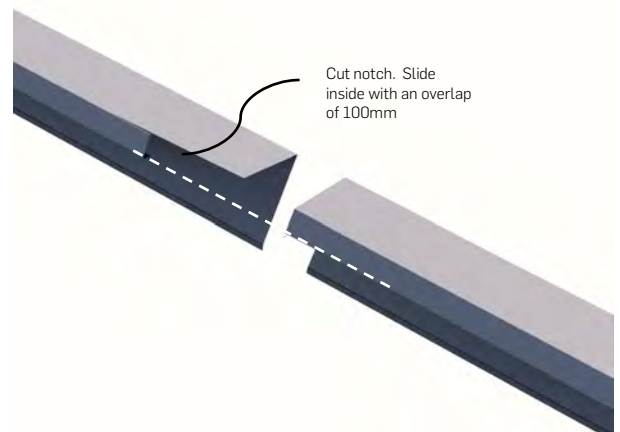

# SPLIT GABLE BARGE DETAIL

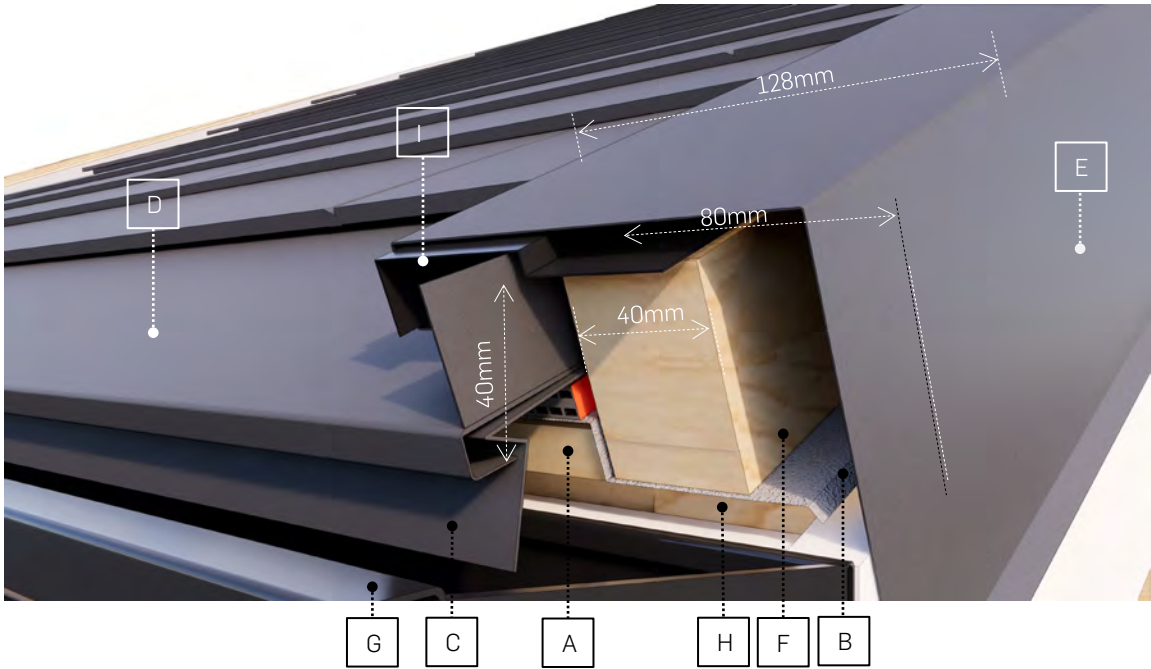

## COMPONENTS

- A. Structural grade 15mm thick plywood
- B. Synthetic underlay
- C. 561 Eaves Flashing
- D. Calibre panel
- E. 551 Barge Cover
- F. 50x40mm batten
- G. Gutter
- H. Flying rafter
- I. 564 Split Gable Flashing

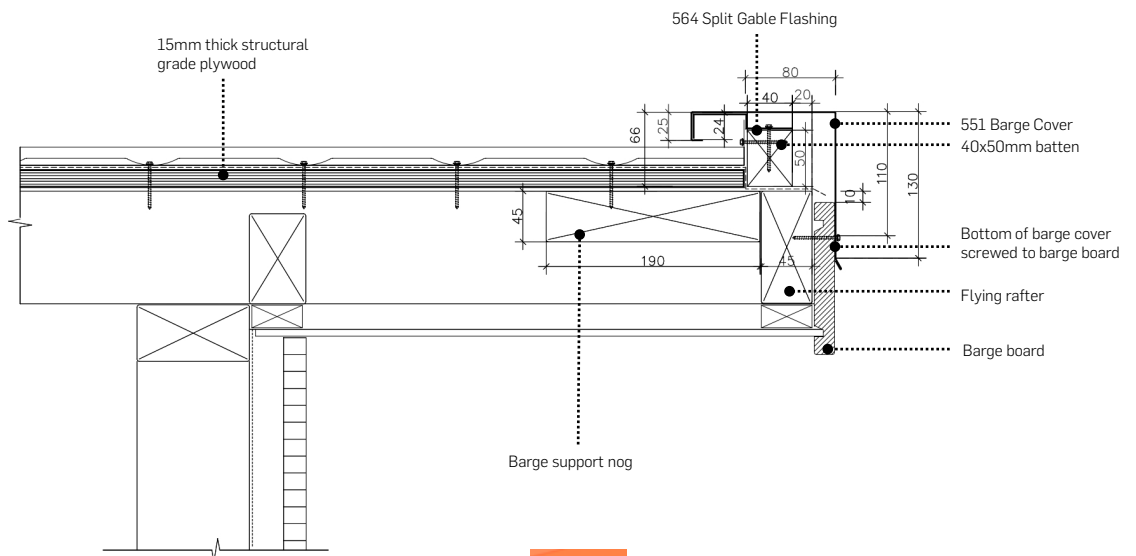
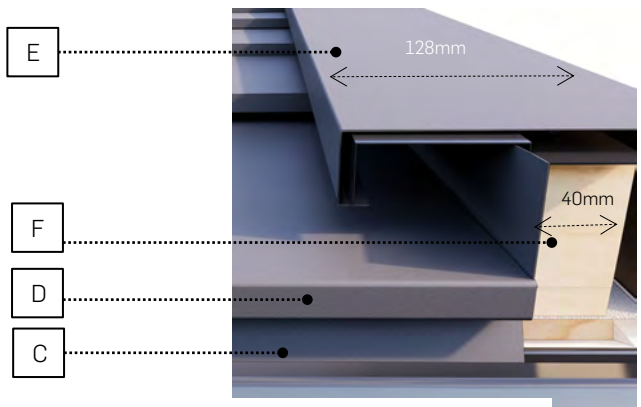

 Color representation of ventilated batten

# 06. WALL JUNCTIONS

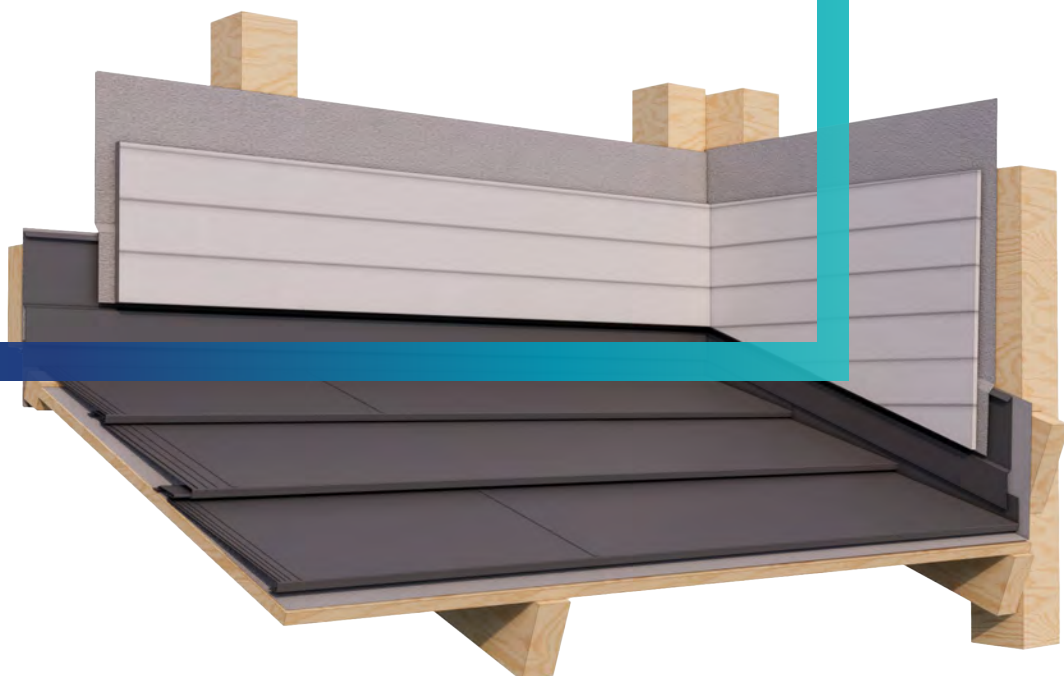

INSTALLATION MANUAL

CALIBRE

 **GERARD**  
Roofing Designed to Endure

# SIDE WALL DETAIL



## COMPONENTS

- A. Structural grade 15mm thick plywood
- B. Synthetic underlay
- C. 50x40mm batten
- D. Calibre panel
- E. 560 Side Wall Flashing

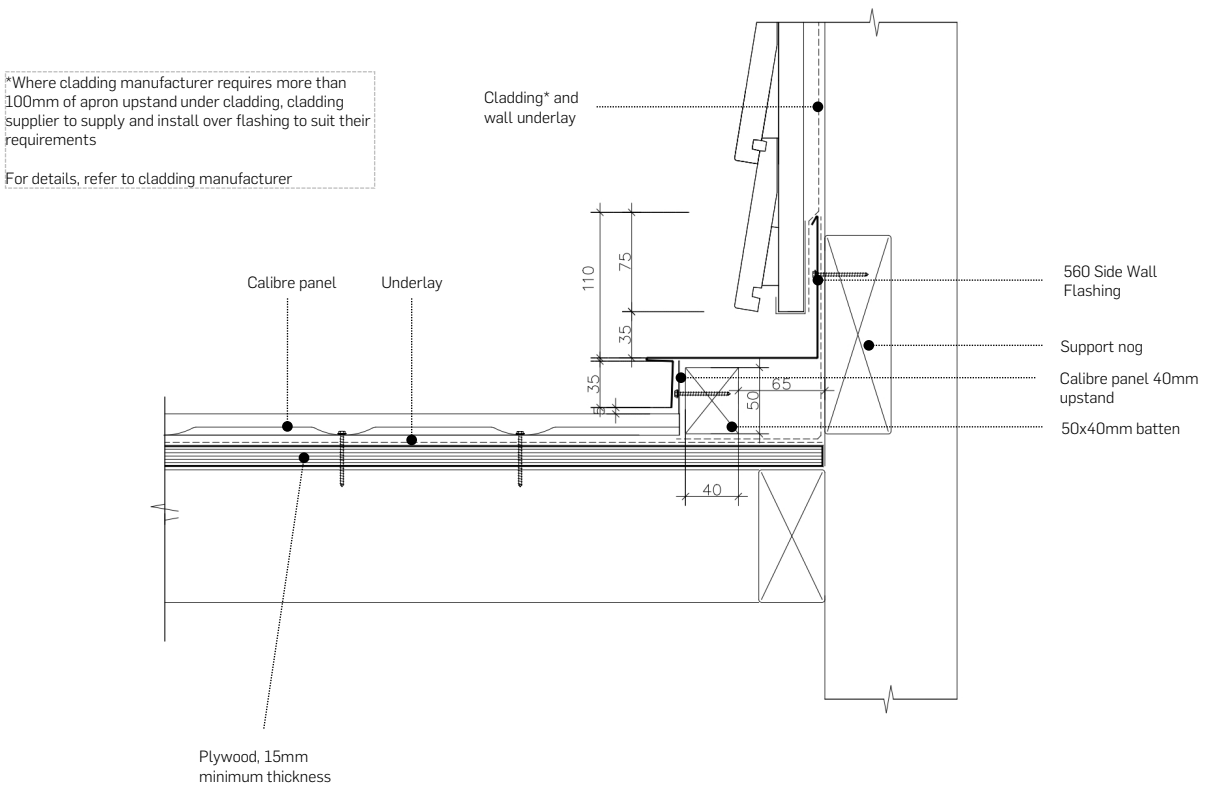

# SIDE WALL INSTALLATION

## INSTALLATION

Once the ply is installed by the builder, install the underlay.



Install a 50x40mm batten running parallel to the wall, spaced 57mm from the wall. Install battens down the hip following the instructions in the Hip Installation section.



Fix the 560 Side Wall Flashing to the support nog in the wall. Wall underlay should lay over the top of the side flashing, while the roofing underlay should lie between the side flashing and the wall.



Once side flashings are installed, the builders can install the wall cladding.

Measure Calibre panels and create a 40mm upstand. Slip the Calibre panel upstand behind the side wall flashing and fix into the batten.



Fasten the bottom of the side wall flashing into the batten.



# HEAD WALL DETAIL

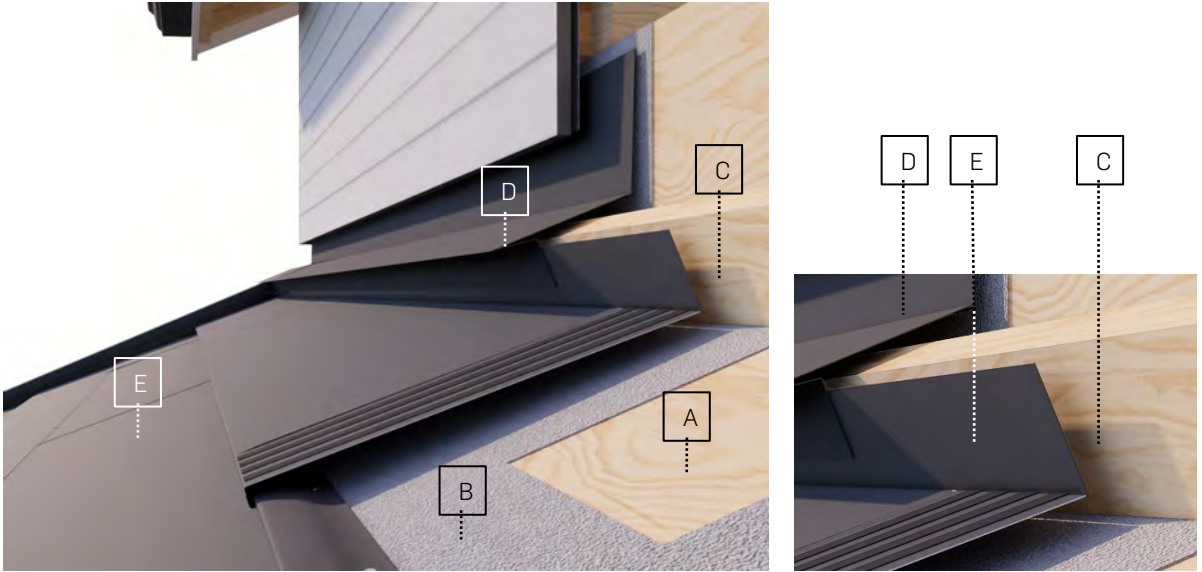

## COMPONENTS

- A. Structural grade 15mm thick plywood
- B. Synthetic underlay
- C. 50x40mm batten
- D. 558 Head Wall Flashing
- E. Calibre panel

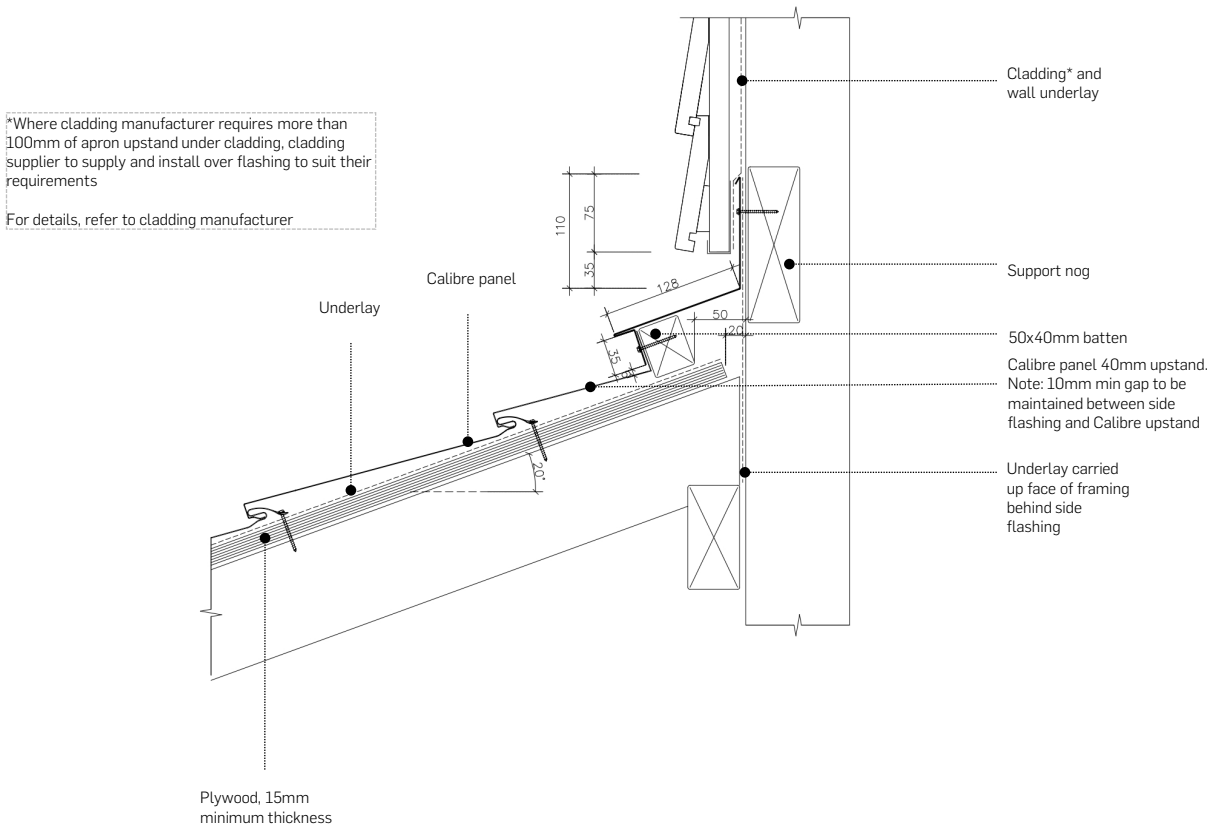



# HEAD WALL INSTALLATION

## SETTING OUT

Roof framing and wall underlay are installed by builders. Install roofing underlay across the plane of the roof, and a separate piece up the wall, large enough to line the wall above the head wall flashings. There must be a 20mm gap between the wall and roof to ensure adequate airflow.

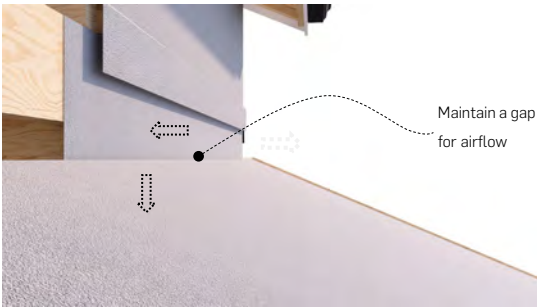

Install a 50x40mm batten running parallel to the wall, spaced 57mm from the wall.

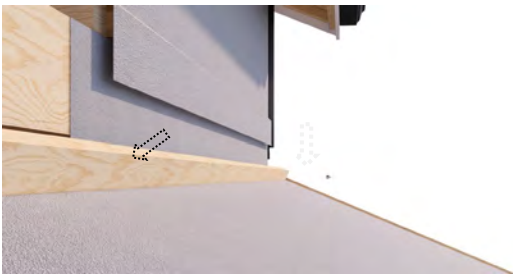

## INSTALLATION

Install a 558 Head Wall Flashing, fastening the head only into the support nog in the wall. Wall underlay should lay over the top of the head wall flashing, while the roofing underlay should lie between the head wall flashing and the wall.



Once side flashings are installed, the builders can install the wall cladding.



Install Calibre panels up the plane of the roof until you reach the top course. Prepare your top course panel with a minimum of 40mm upstand at the head. Hook this under the head wall flashing and fasten into the batten.

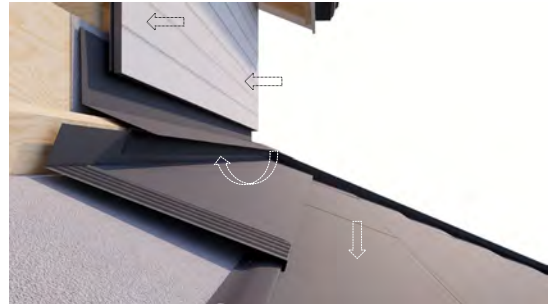

Secure the bottom of the head wall flashing into the batten.

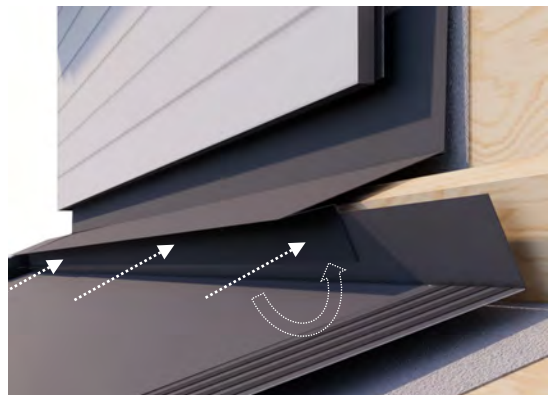

# HEAD WALL DETAIL - VENTILATED

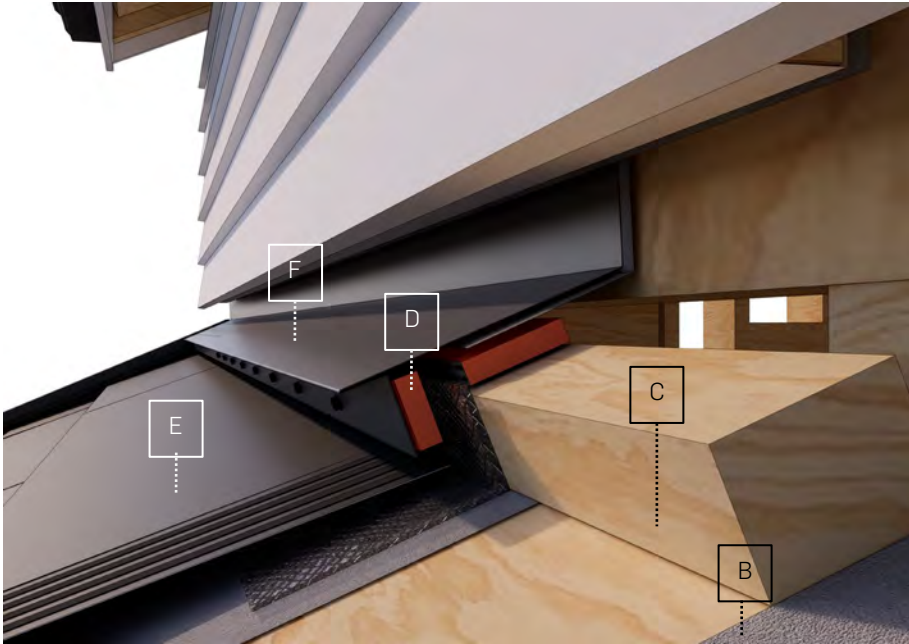

## COMPONENTS

- |  |                           |
|--|---------------------------|
| A. Structural grade 15mm thick plywood | D. Ventilated batten      |
| B. Synthetic underlay                  | E. Calibre panel          |
| C. 40x50mm batten                      | F. 558 Head Wall Flashing |

\*Where cladding manufacturer requires more than 100mm of apron upstand under cladding, cladding supplier to supply and install over flashing to suit their requirements  
For details, refer to cladding manufacturer

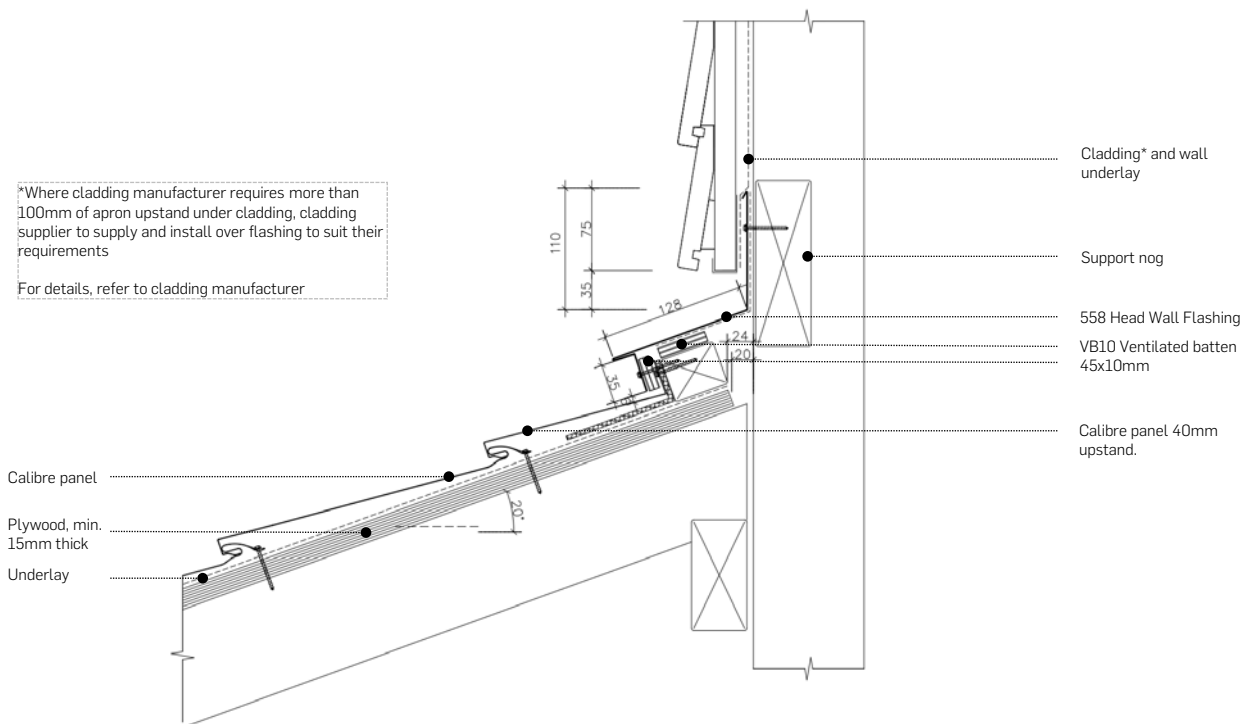

 Color representation of ventilated batten

# HEAD WALL INSTALLATION - VENTILATED

## SETTING OUT

Roof framing and wall underlay are installed by builders. Install roofing underlay across the plane of the roof, and a separate piece up the wall, large enough to line the wall above the head wall flashings. There must be a 20mm gap between the wall and roof to ensure adequate airflow.

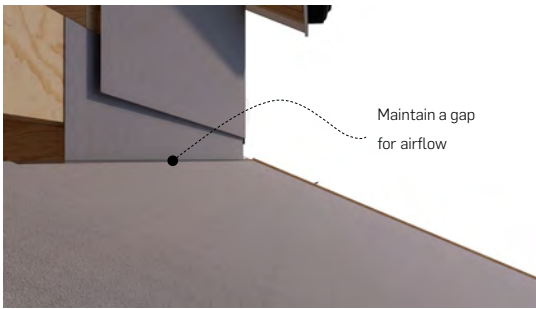

Install a 50x40mm batten running parallel to the wall, spaced 57mm from the wall.



## INSTALLATION

Lay a ventilated mat along the front of the batten, down the plane of the roof.

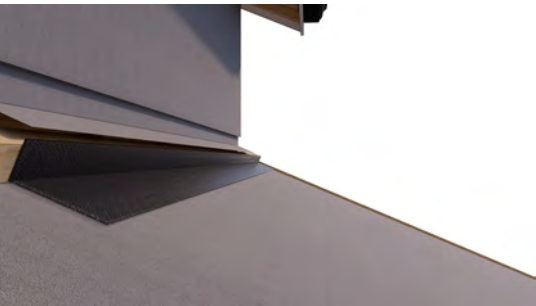

Install ventilated battens along the top and front of the batten.

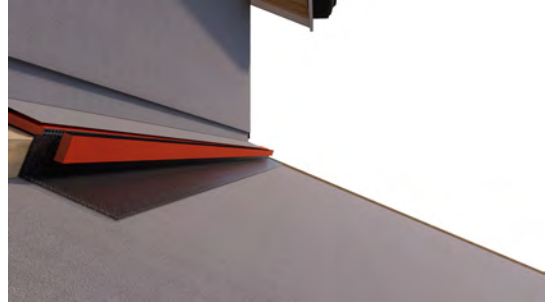

Install a 558 Head Wall Flashing, fastening the head only into the support nog in the wall. Wall underlay should lay over the top of the head wall flashing, while the roofing underlay should lie between the head wall flashing and the wall.

Install Calibre panels up the plane of the roof until you reach the top course. Prepare your top course panel with a minimum of 40mm upstand at the head. Hook this under the head wall flashing and fasten into the batten.

Secure the bottom of the head wall flashing into the batten.



The builders can now install the wall cladding.



## HIP TO WALL JUNCTION DETAIL

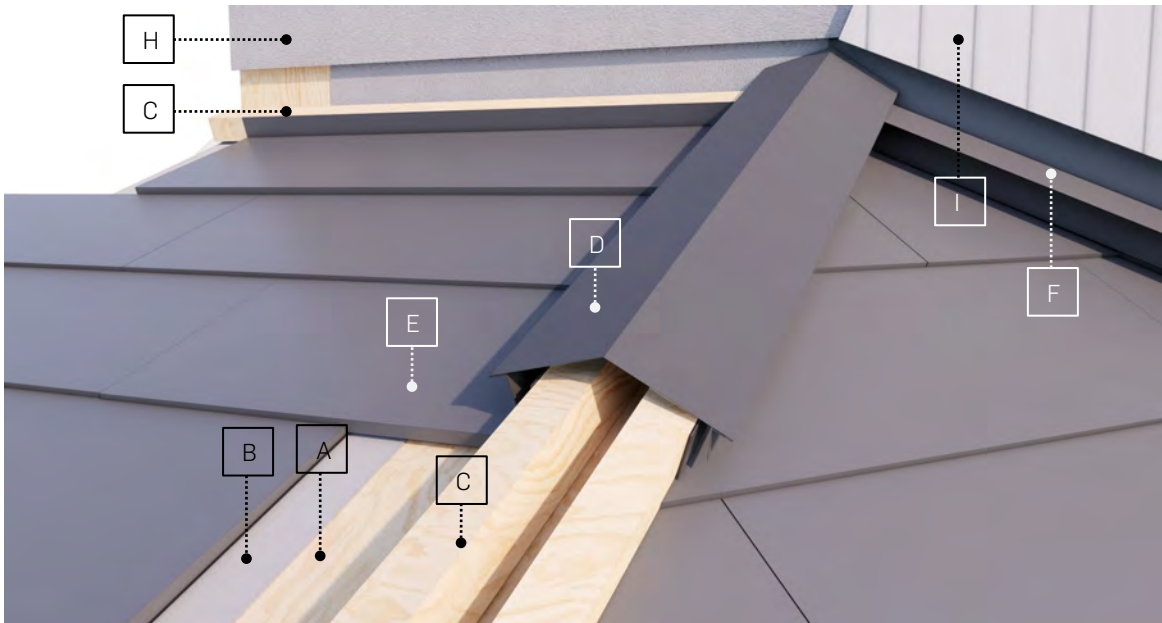

### COMPONENTS

- |                             |                           |
|-----------------------------|---------------------------|
| A. Structural grade plywood | F. 560 Side Wall Flashing |
| B. Synthetic underlay       | G. 558 Head Wall Flashing |
| C. 50x40mm batten           | H. Wall Underlay          |
| D. 550 Long Angle Trim      | I. Building cladding      |
| E. Calibre panel            |                           |

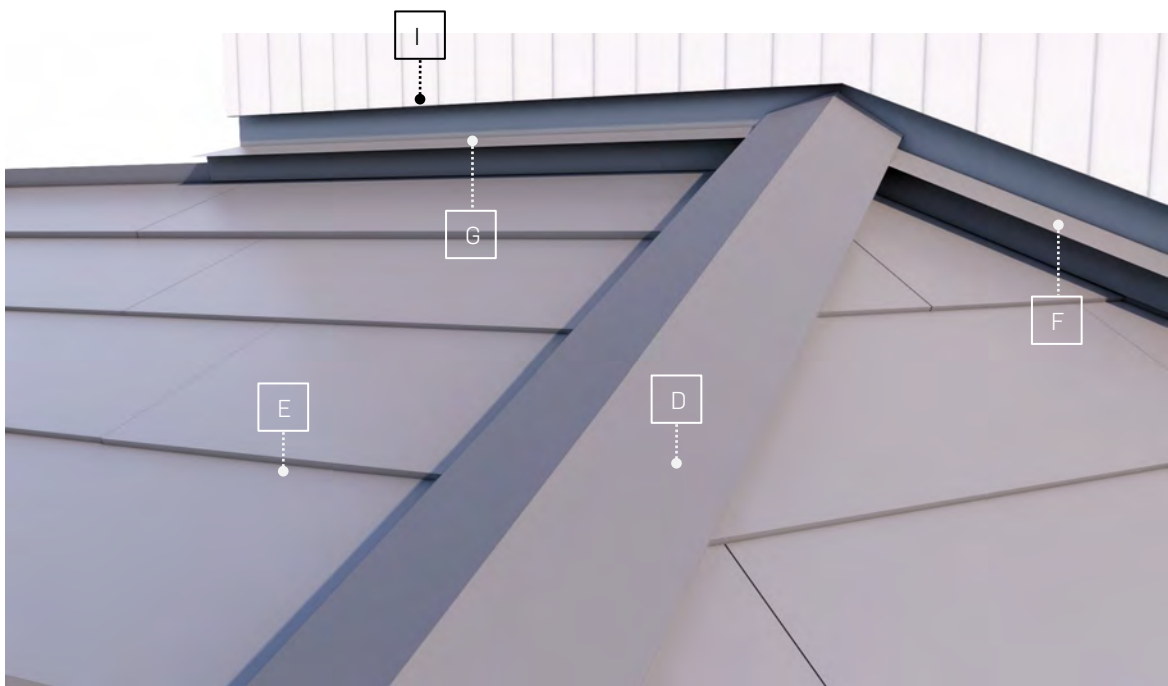

## HIP TO WALL JUNCTION INSTALLATION

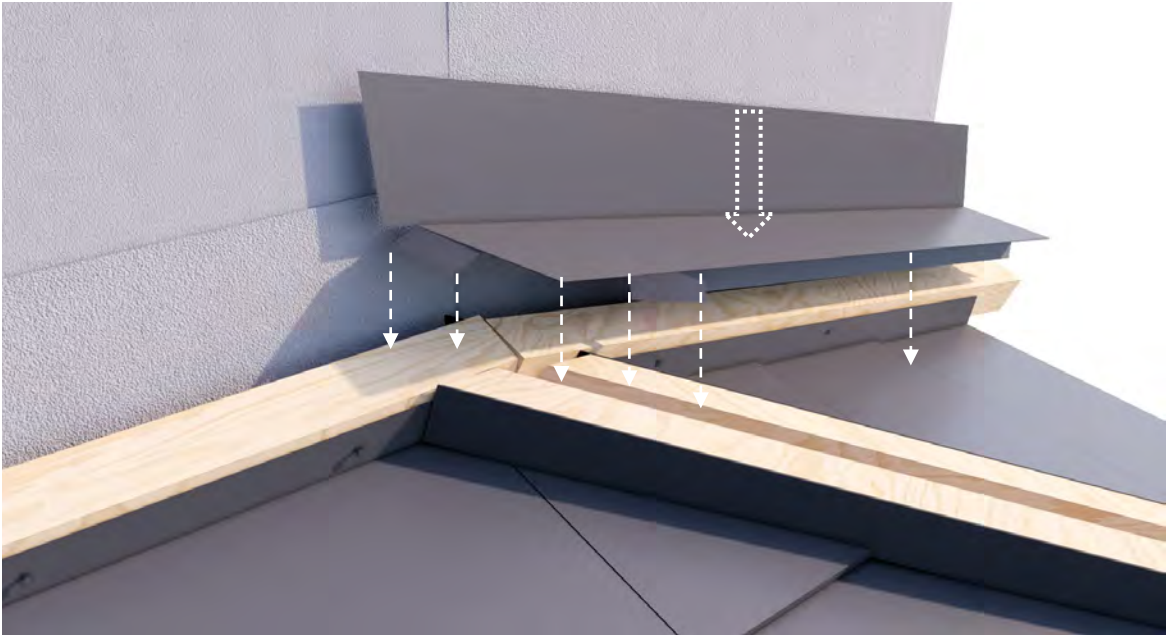

### HEAD WALL FLASHING

Prepare your 558 Head Wall Flashing. Measure your cut line using the angle of the hip. Cut two tabs, one in the side and one underneath as the images below show.

The tabs align on either side of the hip battens.

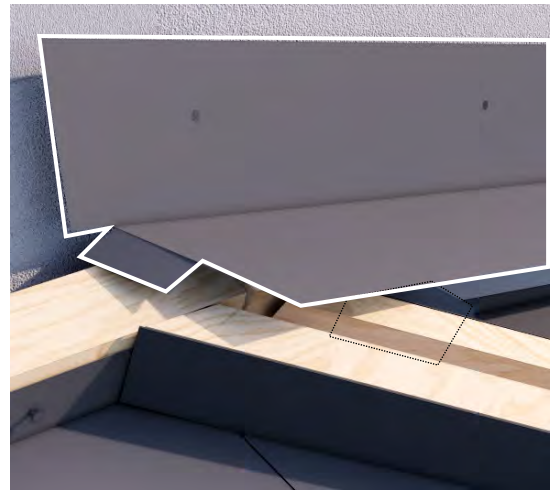
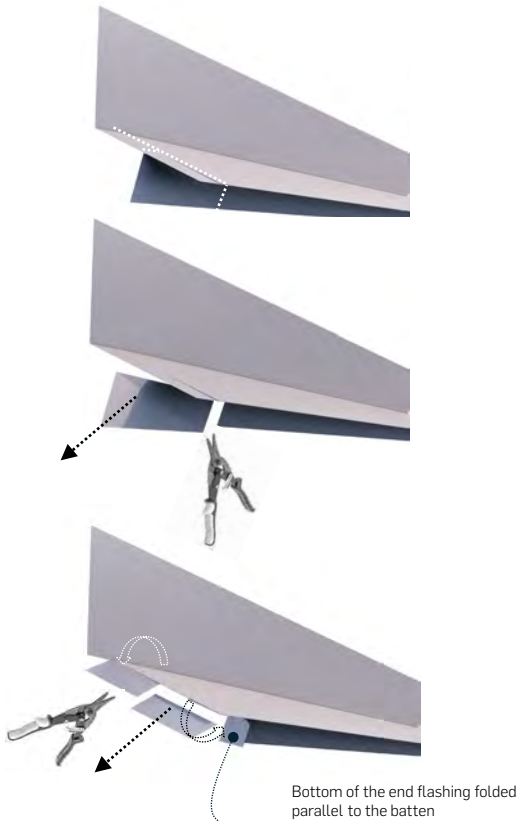

Fit flashing over the junction and fasten in place.

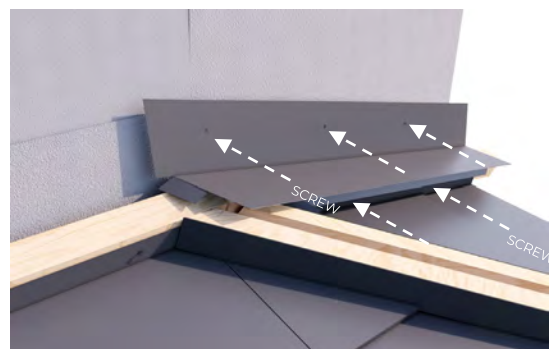

## HIP TO WALL JUNCTION INSTALLATION

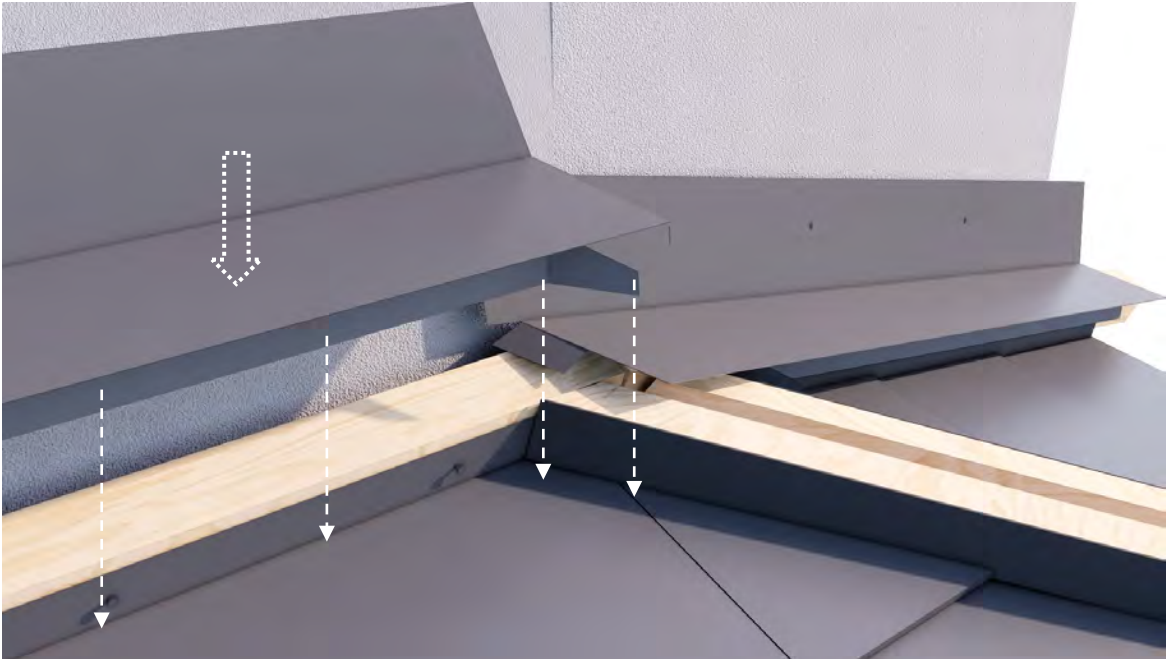

## SIDE WALL FLASHING

Prepare your 560 Side Wall Flashing by measuring and cutting to the angle of the hip. Cut a tab in the underside to align with the hip batten as the images below show.

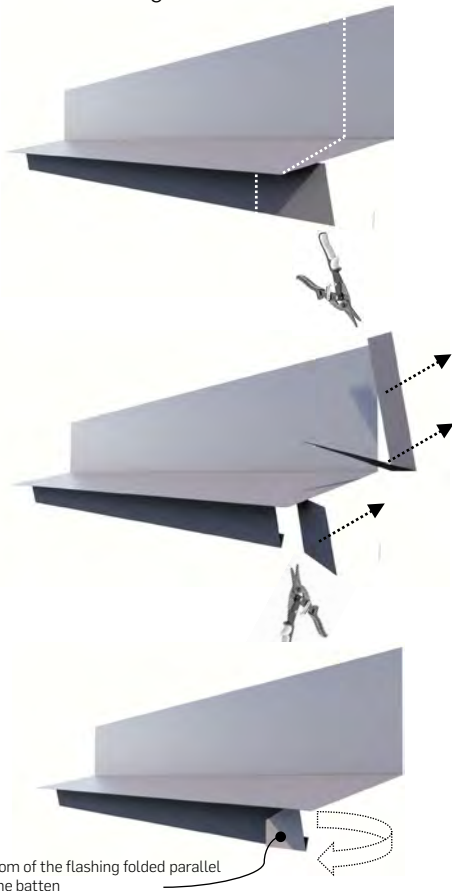

Bottom of the flashing folded parallel To the batten

Fit flashing over the junction, overlapping the head wall flashing. Apply silicone between the flashings and fasten in place.

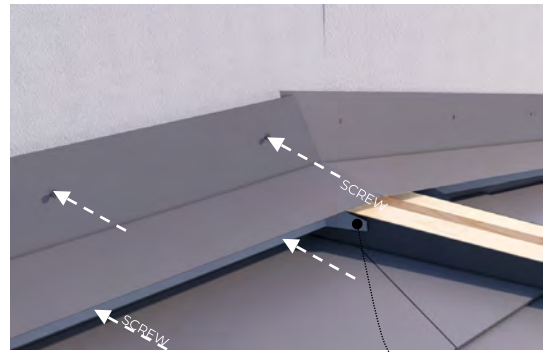

Bottom of the flashing folded parallel To the batten

# HIP TO WALL JUNCTION INSTALLATION

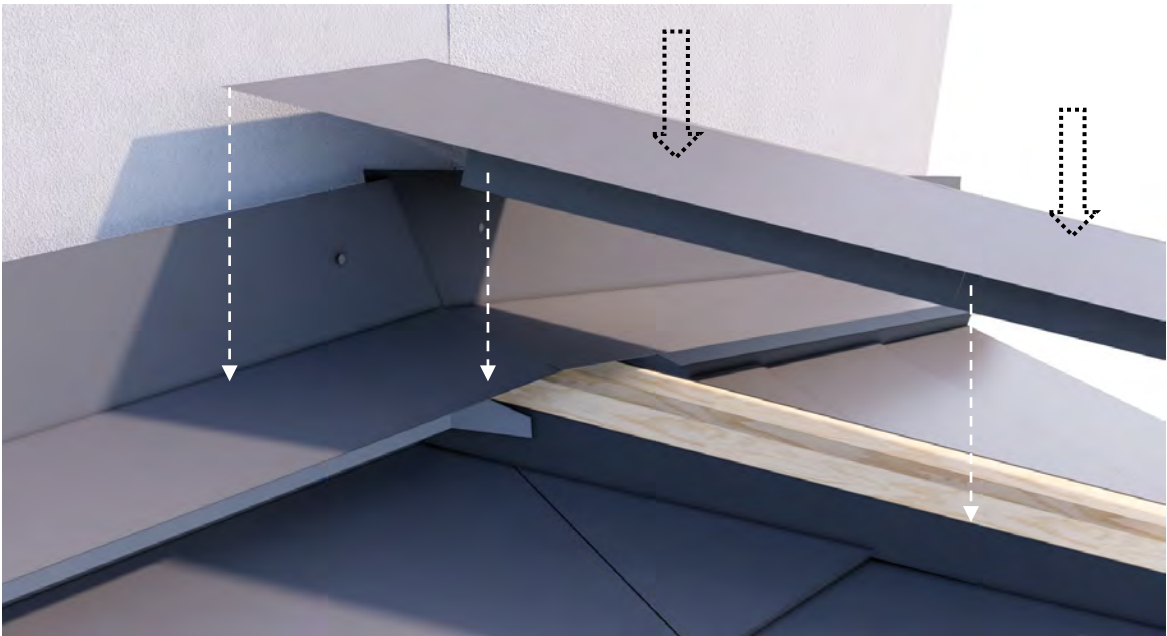

## TRIM INSTALLATION

On a 550 Long Angle Trim, measure the angle of the hip to wall and mark a cut line. Mark the struts 128mm from the edge of the cut line to allow the trim to sit on top of the installed head and side wall flashings.

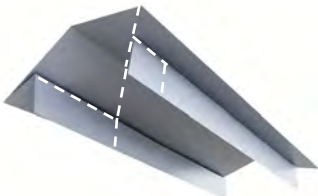

Cut along the struts horizontally. When 128mm has been reached, measure 25mm back to create a notch. Cut off the excess.

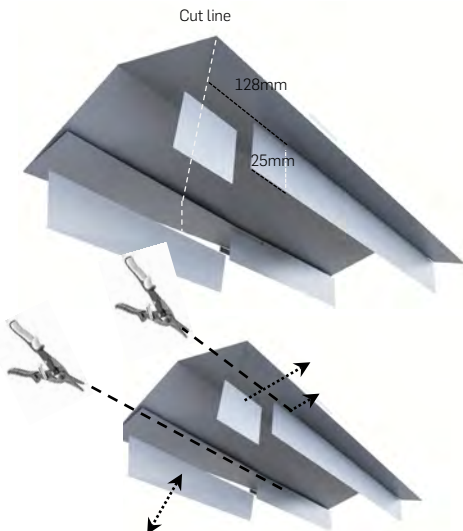

Cut along the cut line.

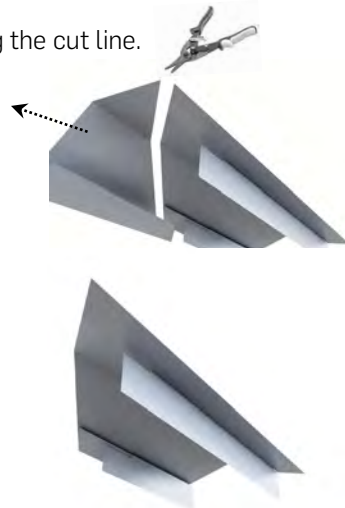

Using the notches, slot into the head and side wall flashings. Fasten in place.

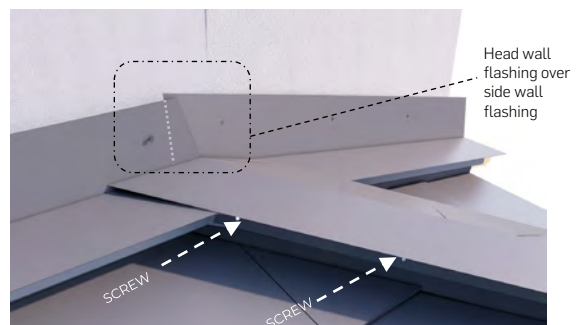

# 07. ROOF PENETRATIONS

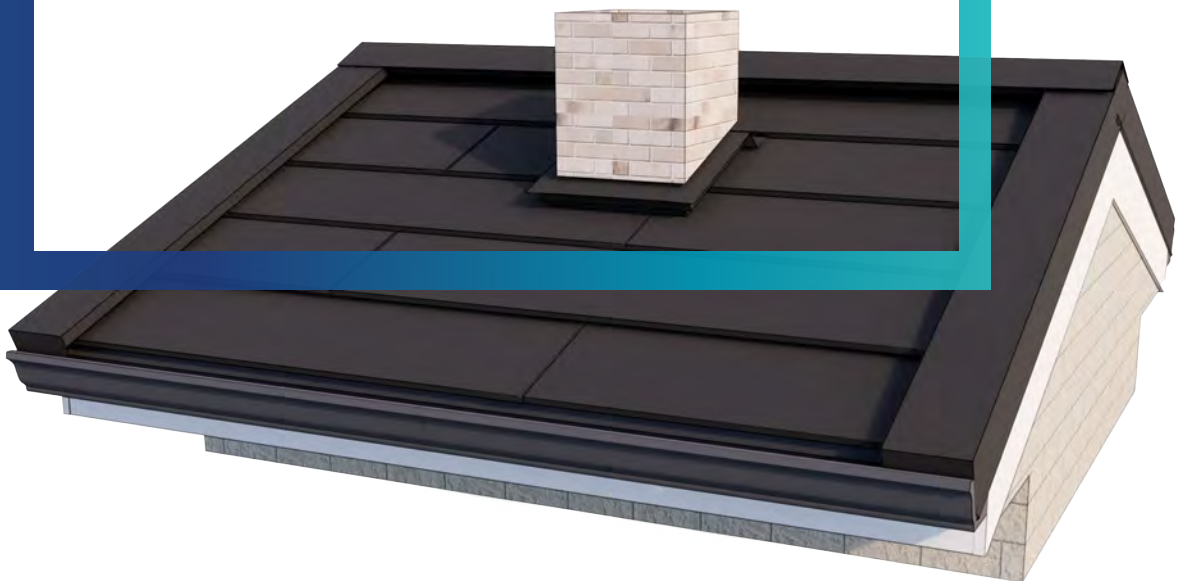

INSTALLATION MANUAL  
CALIBRE



# CHIMNEY PENETRATION DETAIL

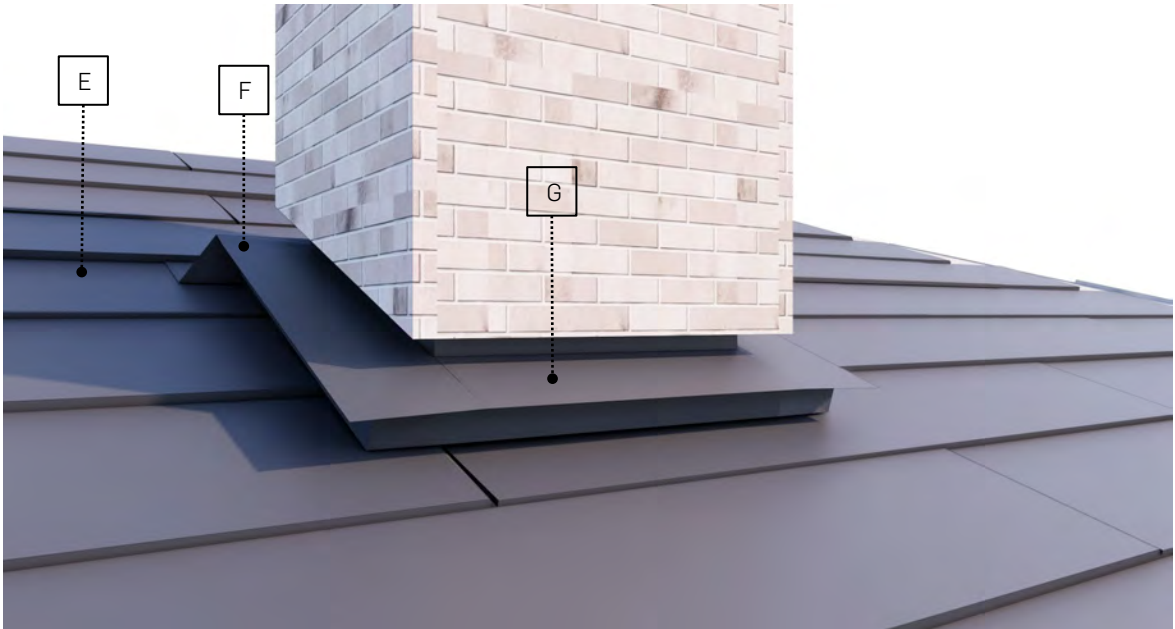

## COMPONENTS

- |  |                           |
|--|---------------------------|
| A. Structural grade 15mm thick plywood | E. Calibre panel          |
| B. 40x50mm batten                      | F. 560 Side Wall Flashing |
| C. Synthetic underlay                  | G. 558 Head Wall Flashing |
| D. Chimney back flashing               | H. Hex roof screw         |

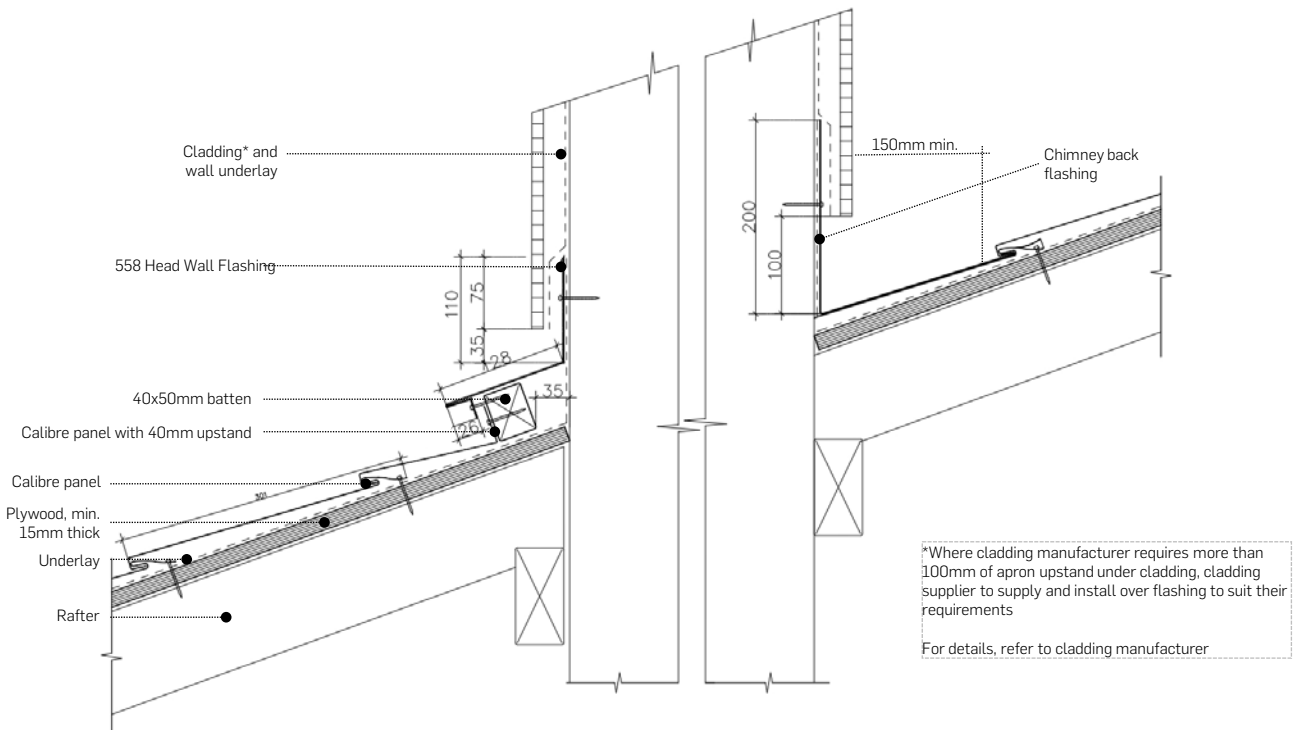

# CHIMNEY PENETRATION INSTALLATION

## INSTALLATION

For chimneys up to 1 metre in width.

Once the ply is installed, install the underlay. Fix 50x40mm battens around the penetration spaced 57mm from the wall.

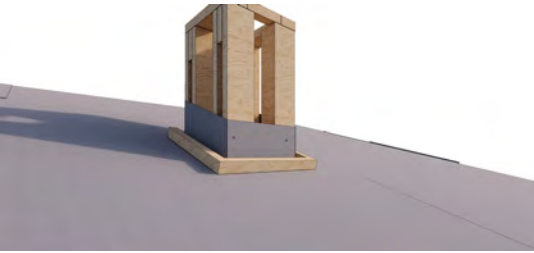

Install Calibre panels up the plane of the roof, creating minimum 40mm upstands around the penetration.



Install 558 Head Wall Flashings and 560 Side Wall Flashings around the front and sides of the penetration.

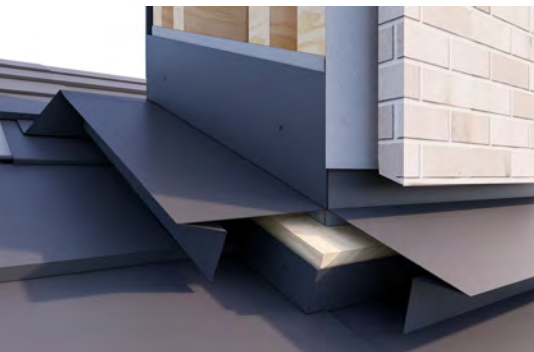

The builders can now apply wall underlay



Prepare your back flashing. The head should have a 10mm turn-back to allow the next panel to hook into it.

Install the back flashing.

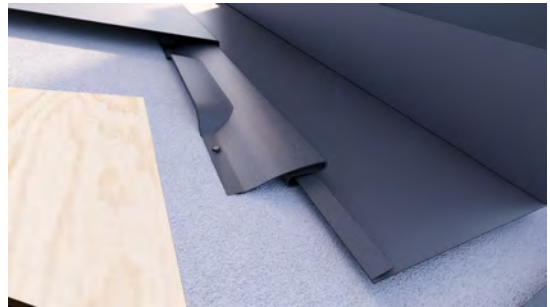

Once completed, the builders can install wall cladding to the chimney.



# DEKTITE PENETRATION

## INSTALLATION

Cut through the underlay taking care to create a turn up around the pipe penetration.



Install Calibre panels up the plane of the roof to the pipe. When the penetration is reached, pierce a hole in the panel at the centre of the pipe's location.

Cut to the circumference of the pipe and fold upwards, creating a turn up around the pipe.



Install the next course of panels.



Cut the Dektite cone where indicated for the relevant pipe size.

Slide the Dektite flashing down over the pipe. Water can be used as a lubricant.

Apply neutral cure silicone or double-sided roofing membrane tape on the underside of the flange.

Press pipe flashing into contours of the roof panel.



Fasten with self-tapping or self-drilling screws, or selected pop rivets.



# RAISED SKYLIGHT PENETRATION DETAIL

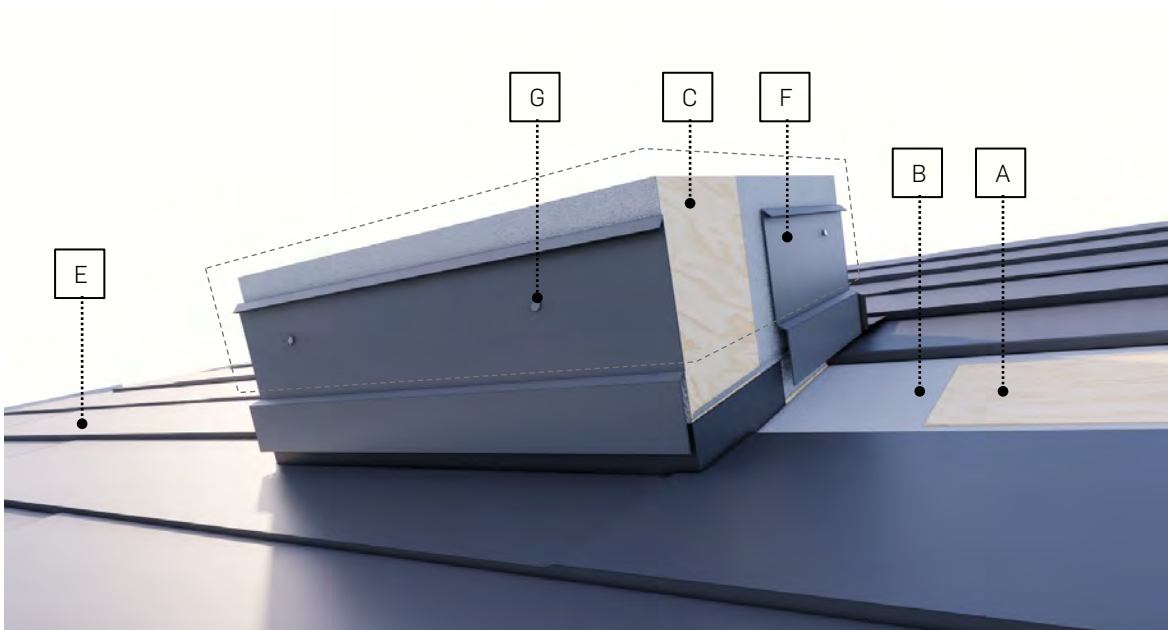

## Components

- A. Structural grade 15mm thick plywood
- B. Synthetic underlay
- C. Skylight frame/curb/nog
- D. Skylight back flashing
- E. Calibre panel
- F. 104 Side Flashing
- G. Hex roof screw
- H. Proprietary skylight set\*

\*not shown

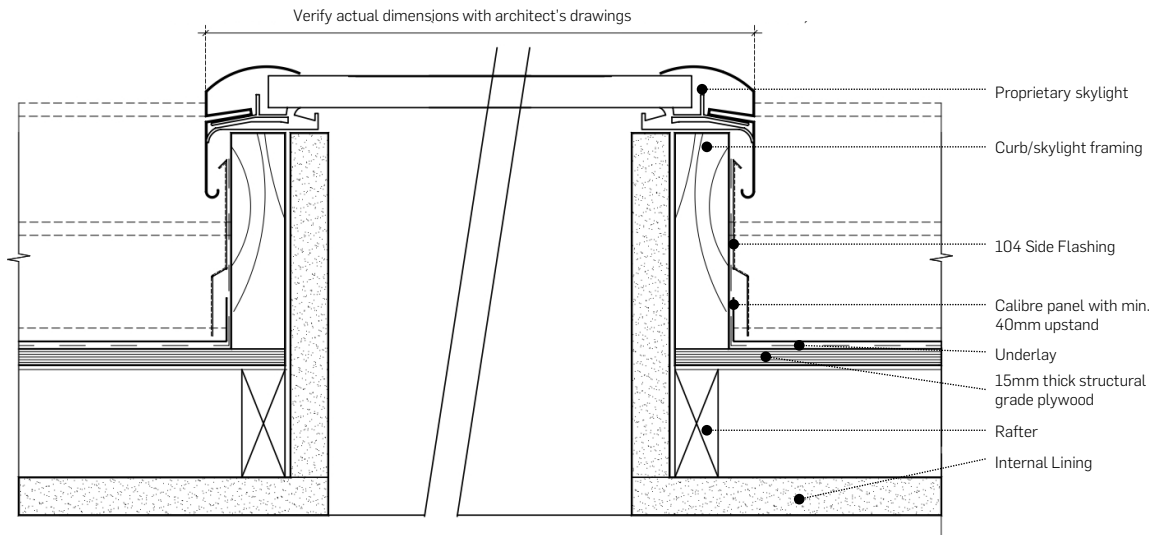
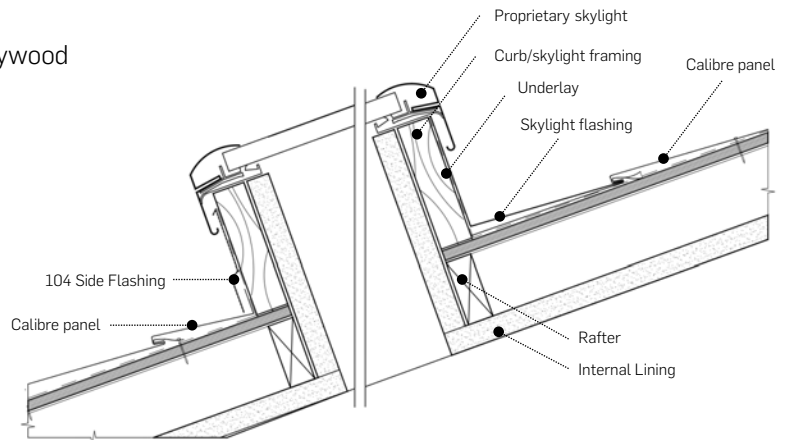

# RAISED SKYLIGHT PENETRATION INSTALLATION

## METHOD

Install underlay across the roof, with underlay running up the sides of the penetration.

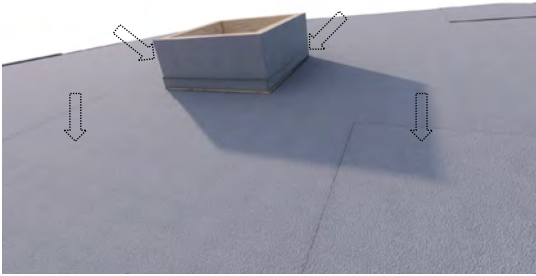

Install Calibre panels up the plane of the roof, creating an upstand of at least 40mm at the penetration.

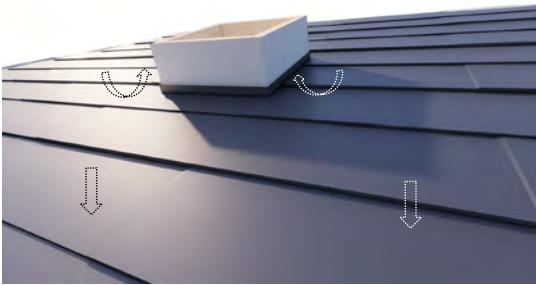

Install 104 Side Flashings to the front and sides of the penetration.

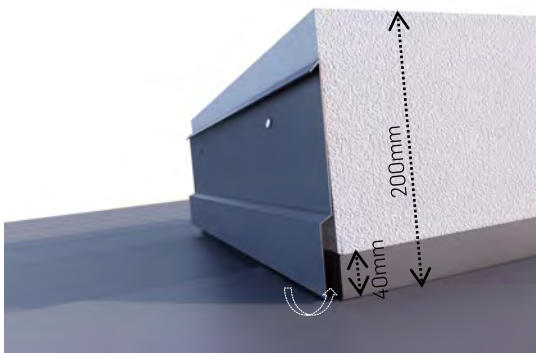

Install back flashing. The upstand on the back flashing should be 200mm minimum height.

The head of the back flashing should have a 10mm turn-back to allow the next panel to hook into it.

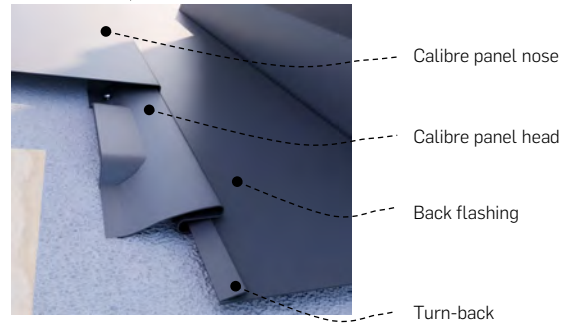
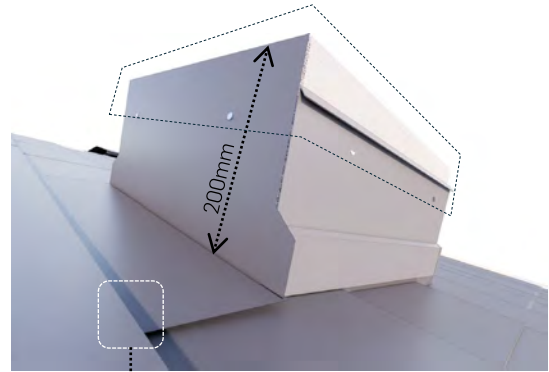

Install skylight following the manufacturer's instructions.



# INSET SKYLIGHT PENETRATION DETAIL

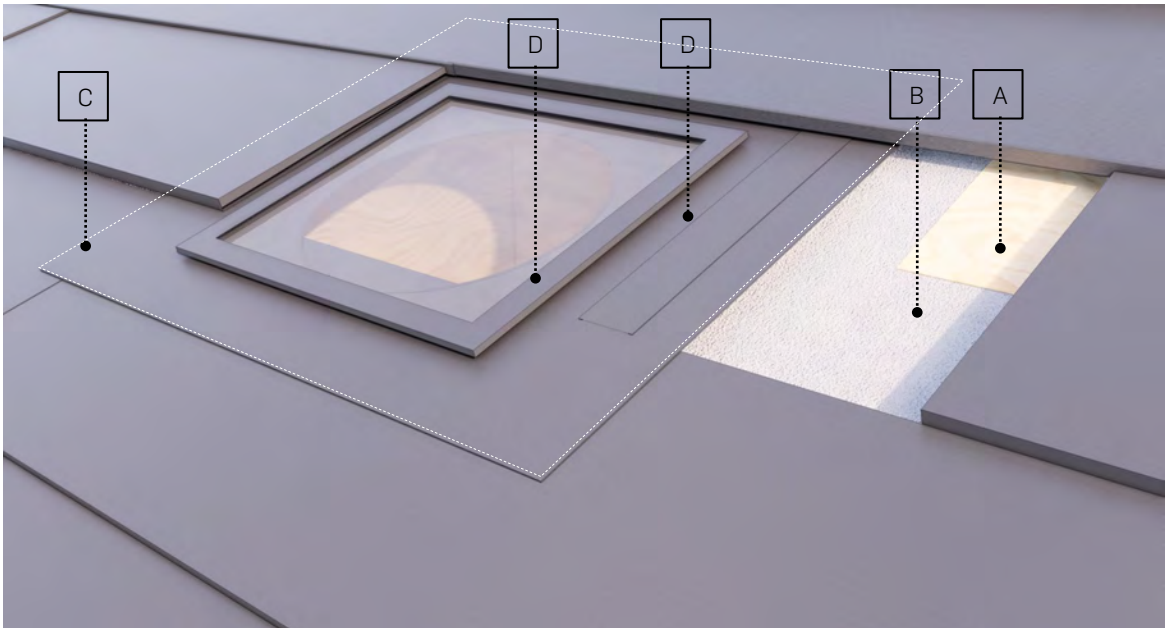

## COMPONENTS

- A. Structural grade 15mm thick plywood
- B. Synthetic underlay
- C. Calibre panel
- D. Proprietary skylight set
- E. Aluminum frame + cover

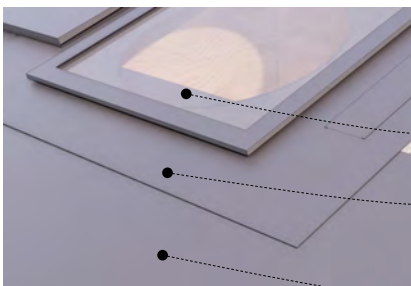
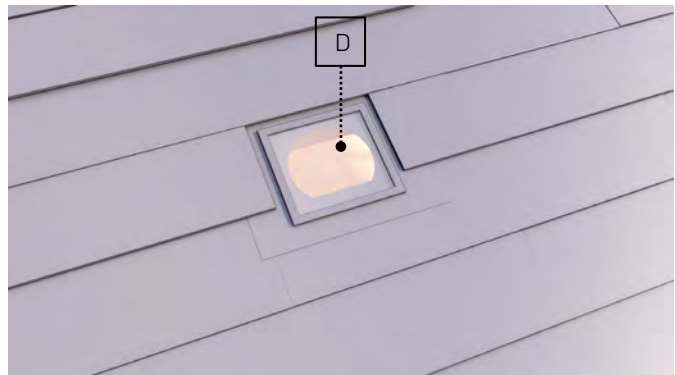

- Skylight glass cover
- Skylight aluminum tray frame sitting over Calibre panel

Calibre panel

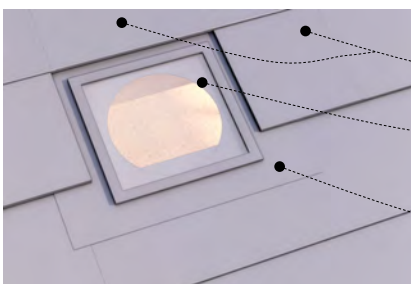

Calibre panel (over skylight tray frame)

Skylight cover

Skylight aluminum tray frame sitting over Calibre panel

# INSET SKYLIGHT PENETRATION INSTALLATION

## METHOD

Once the ply has been installed, install the underlay across the plane of the roof. The underlay should lie flush with the edges of the penetration.

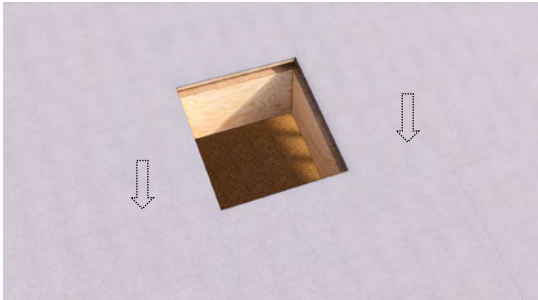

Install Calibre panels up to the bottom of the penetration.

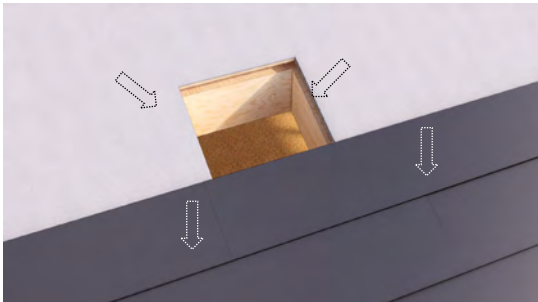

Install the skylight tray overlapping the installed Calibre panels.

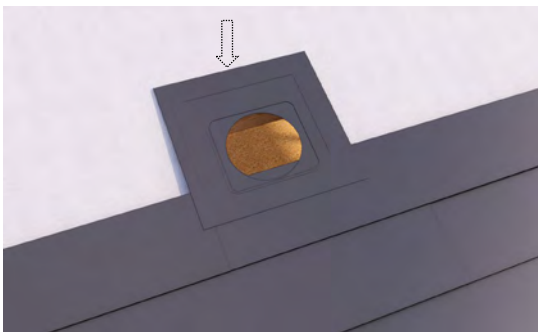

Install the glass cover into the skylight tray.

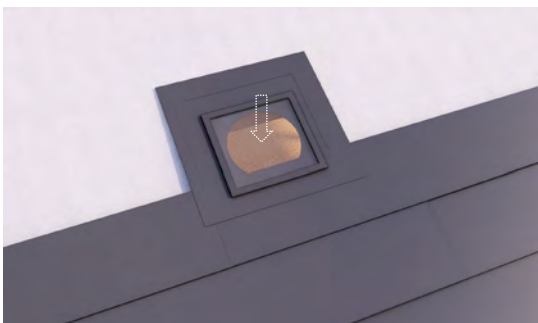

Install the next course of panels, stopping 25mm from the edge of the glass framing. Where panels are installed against the skylight tray, cut and fold the side of the panel down creating a tidy end.

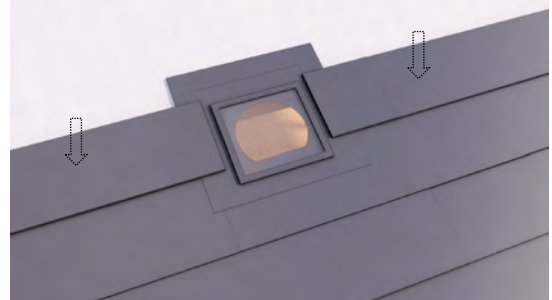

Continue installing Calibre panels up the plane of the roof.

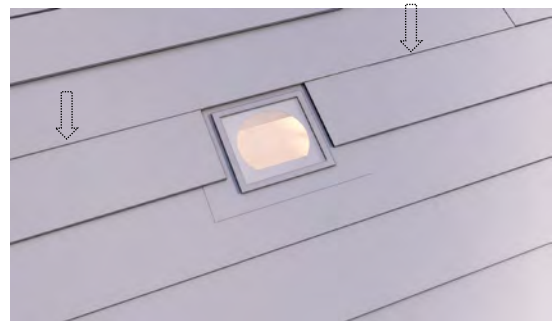

# 08. OTHER DETAILS

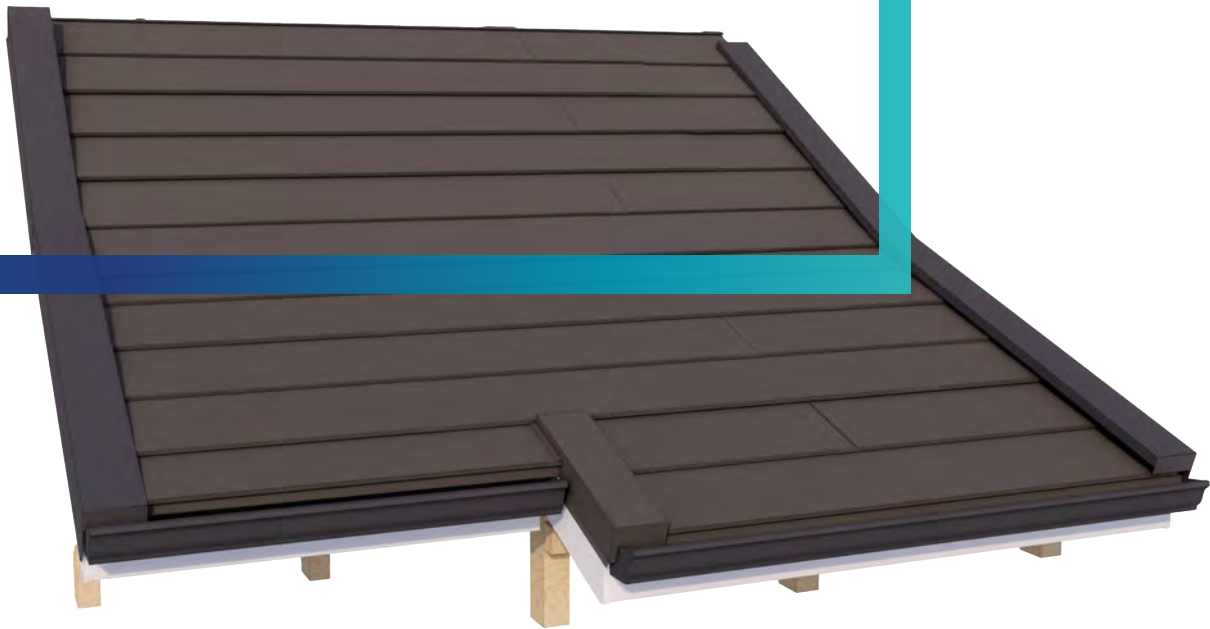

INSTALLATION MANUAL  
CALIBRE



# CHANGE OF PITCH DETAIL

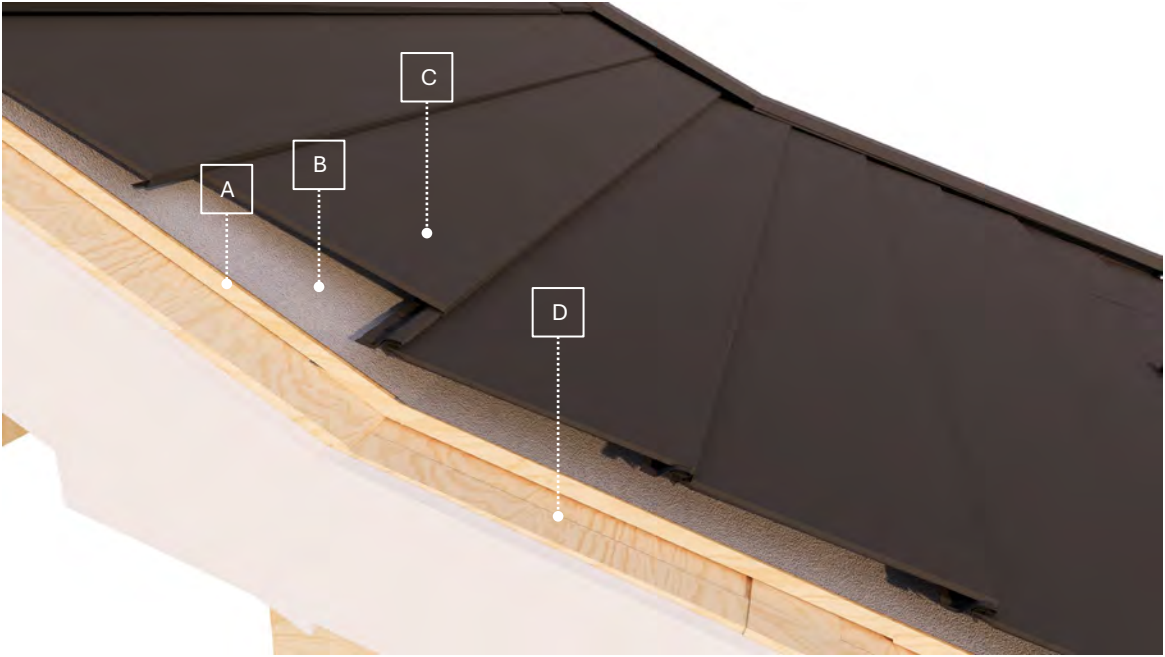

Components:

- A. Structural grade 15mm thick plywood
- B. Synthetic underlay
- C. Calibre panel
- D. Truss/rafters

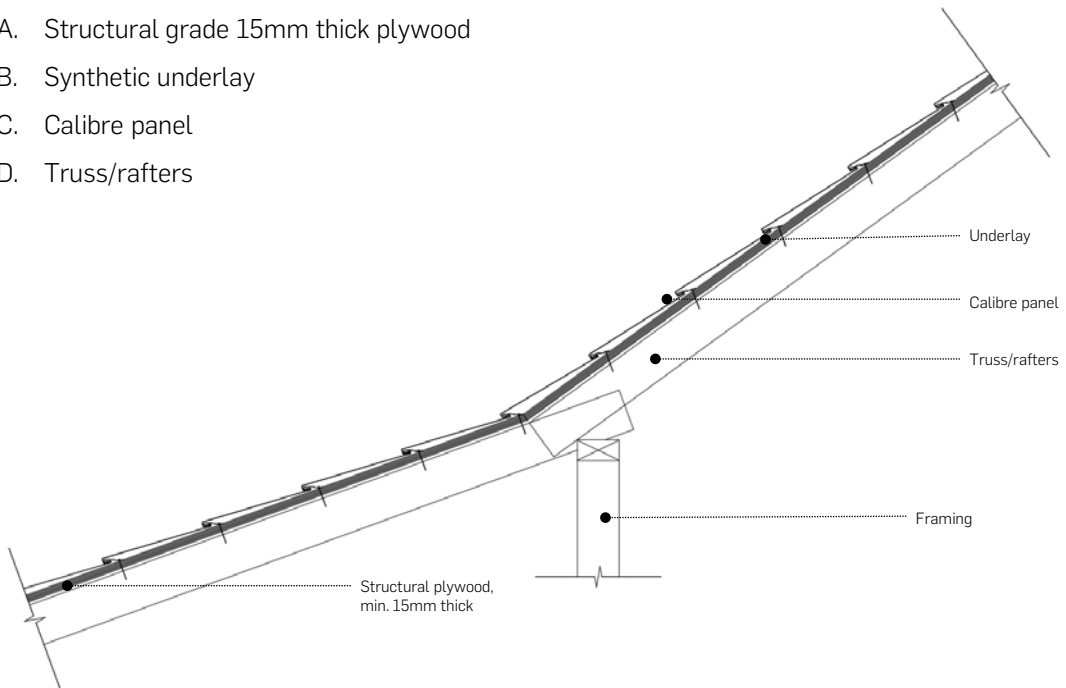

# CHANGE OF PITCH DETAIL SHORTCOURSE METHOD

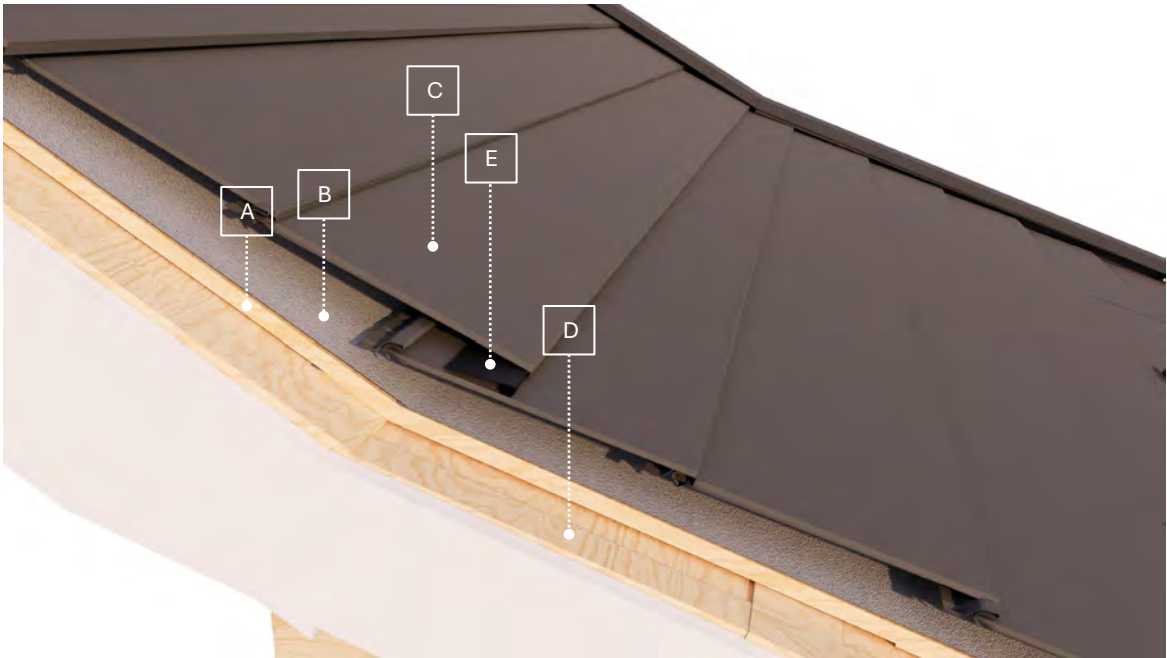

## Components:

- A. Structural grade 15mm thick plywood
- B. Synthetic underlay
- C. Calibre panel
- D. Truss/rafters
- E. 417 Short Course

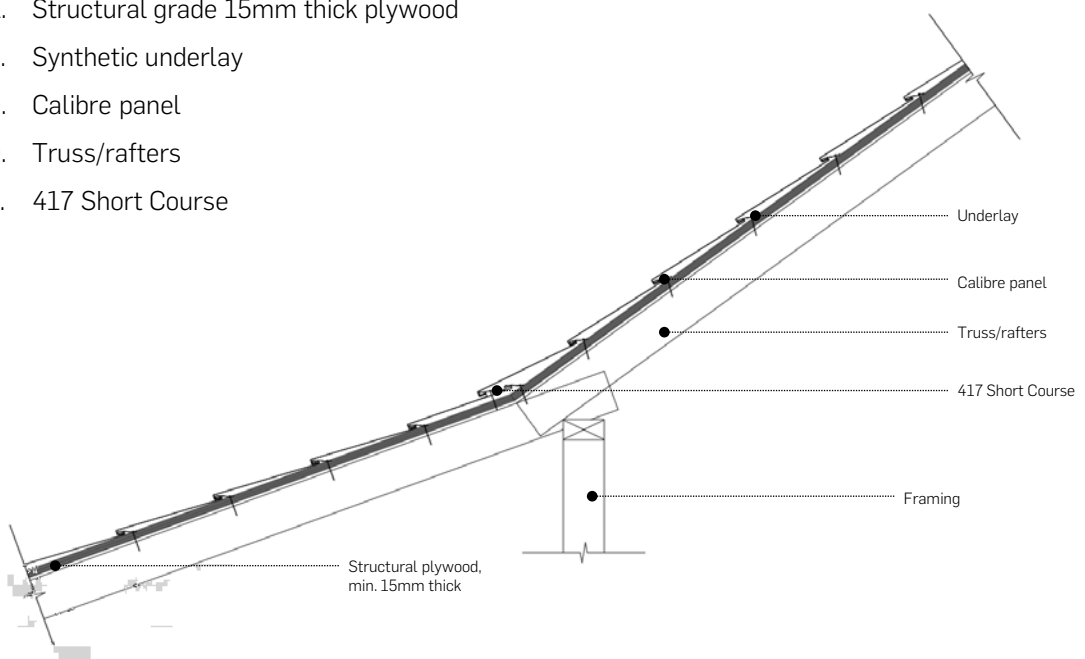

RoofTG Pacific Ltd accepts no liability if the Gerard roofing system is not used in accordance with the instructions contained in this publication. Substitution of specified or recommended components with alternative brands can compromise performance. The Gerard system is not generic and must be installed as specified using Gerard branded components. This publication may be superseded by a new publication. RoofTG Pacific Ltd accepts no liability for reliance on publications that have been superseded. Before using this manual check whether this is the current version on the relevant Gerard website.

© RoofTG Pacific Ltd 2024